

Radio Broadcast

ROY MASON, EDITOR

ARTHUR H. LYNCH, TECHNICAL EDITOR



CONTENTS FOR JULY, 1922

<i>Dr. Alexander Graham Bell</i>	- - - - -	<i>Frontispiece</i>
THE MARCH OF RADIO	- - - - -	191
WHEN DE WOLF HOPPER BROADCASTED TO HIS BIGGEST AUDIENCE	-	198
WHAT EVERYONE SHOULD KNOW ABOUT RADIO HISTORY		
	PROF. J. H. MORECROFT	199
AN EVENING WITH DR. ALEXANDER GRAHAM BELL	- DONALD WILHELM	205
INCREASING THE SELECTION POWER OF A RADIO CIRCUIT		
	JOHN V. L. HOGAN	211
PROTECTION OF THE RECEIVING ANTENNA	- - - - - G. Y. ALLEN	214
A CHURCH WITH A MIGHTY CONGREGATION	- - - ARCHIE RICHARDSON	218
RANDOM OBSERVATIONS ON RUNNING A BROADCASTING STATION		
	H. M. TAYLOR	223
RADIO PERSONALITIES	- - - - -	228
REGINALD AUBREY FESSENDEN	- - - - - LUCILLE JOYCE	
NEW RADIO NET FOR ROGUES	- - - - - DONALD WILHELM	231
HOW RADIO CAME TO INDEPENDENCE, KANSAS	- - THOMAS M. GALEY	234
HOW TO BEGIN TO ENJOY RADIO	- - - CAPT. LEON H. RICHMOND, U. S. A.	236
A SIMPLY CONSTRUCTED AND OPERATED SHORT RANGE C. W. TRANSMITTER	- - - - - ZEH BOUCK	240
OUR AMATEUR RADIO RESERVE	- - - - - MAJOR PAUL W. EVANS, U. S. A.	243
RADIO FOG SIGNALS AND THE RADIO COMPASS	- - - - -	247
THE AUDIO PILOTING CABLE IN THE AMBROSE CHANNEL		
	DONALD WILHELM	249
PROGRESS OF RADIO IN FOREIGN LANDS	- - - - -	251
RADIO HELPING US ENJOY THE SUMMER	- - - - - ARTHUR H. LYNCH	255
RADIO IN REMOTE REGIONS	- - - - -	262
THE GRID—QUESTIONS AND ANSWERS	- - - - -	264
PRESENT RADIO BROADCASTING STATIONS IN THE UNITED STATES	- -	270

Copyright, 1922, by Doubleday, Page & Co. All rights reserved
TERMS: \$3.00 a year; single copies 25 cents

F. N. DOUBLEDAY, Pres.

ARTHUR W. PAGE, Vice-Pres.

NELSON DOUBLEDAY, Vice-Pres.

RUSSELL DOUBLEDAY, Sec'y.

S. A. EVERITT, Treas.

JOHN J. HESSIAN, Asst. Treas.

DOUBLEDAY, PAGE & CO.

THE WORLD'S WORK COUNTRY LIFE THE GARDEN MAGAZINE SHORT STORIES EDUCATIONAL REVIEW

CHICAGO: People's Gas Bldg.

GARDEN CITY, N. Y.

NEW YORK: 120 W. 32nd Street

BOSTON: Tremont Bldg.

LOS ANGELES: Van Nuys Bldg.

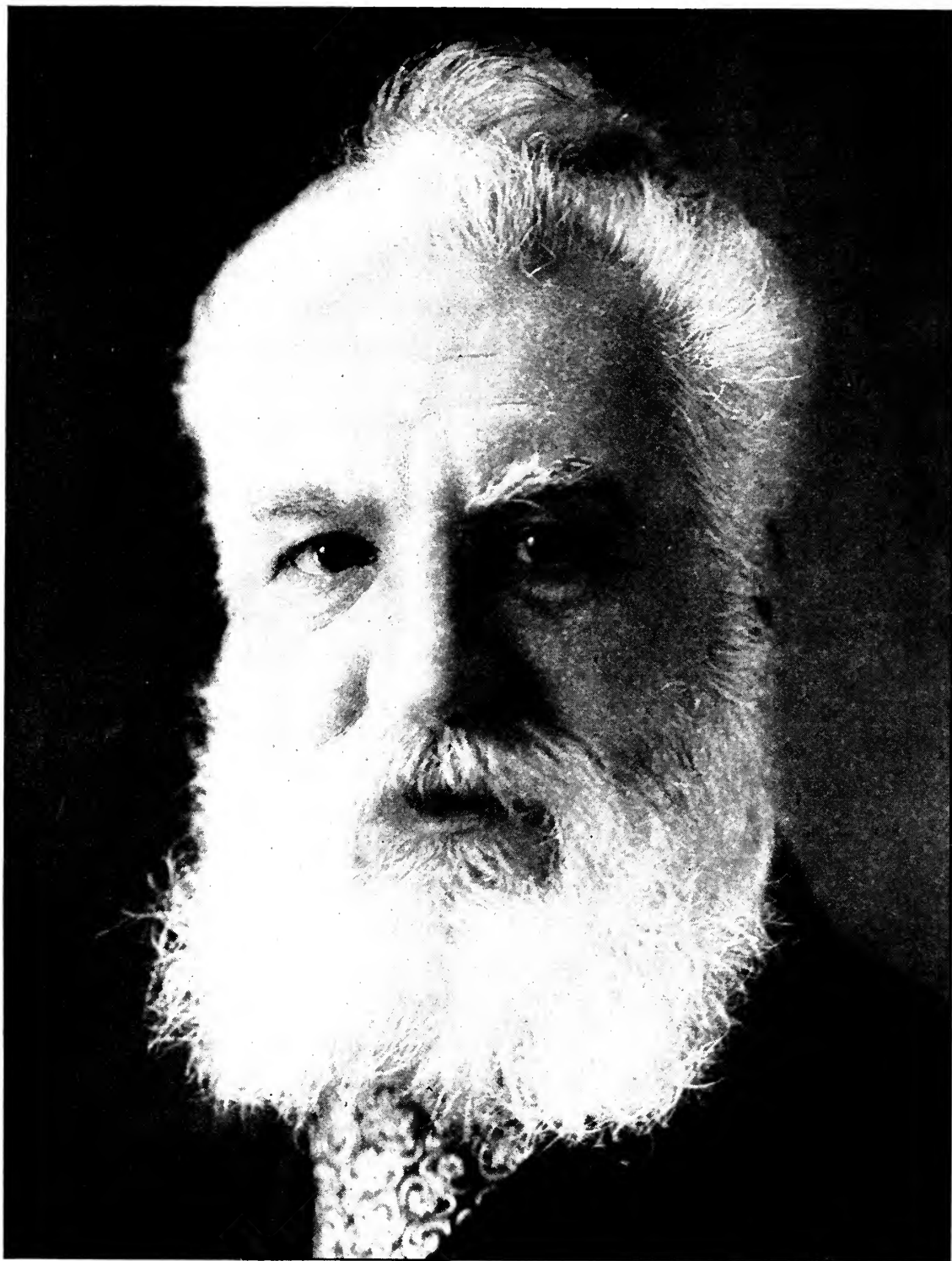

DR. ALEXANDER GRAHAM BELL
Inventor of the Telephone

RADIO BROADCAST

Vol. 1 No. 3



July, 1922

The March of Radio

REPORT OF THE RADIO TELEPHONE COMMITTEE

A VERY important step was taken in the progress of radio telephone development when the committee, called by Secretary Hoover, handed in their final report, containing recommendations as to the proper allocation of wave lengths for the different radio telephone services now existing, or anticipated. The committee, under the leadership of Dr. S. W. Stratton, the Director of the Bureau of Standards, was made up of experts from all branches of radio activity—the military and civil services of the Government, commercial radio engineers, college professors, and representatives of the amateurs, all combined to work out what seemed to be a reasonable division of the frequencies available for radio traffic.

The recommended assignment of wave lengths was as follows—Transoceanic experiments, non-exclusive, 5000-6000 meters; Fixed service, 2850-3300; Mobile service, non-exclusive, 2500-2650; Government broadcasting, non-exclusive, 1850-2050; Fixed station, non-exclusive, 1550-1650; Aircraft radio telephone and telegraph, exclusive, 1500-1550; Government and public broadcasting, non-exclusive, 1050-1500; Radio beacons, exclusive, 950-1050; Aircraft radio telephone and telegraph, exclusive, 850-950; Radio compass service, exclusive, 750-850; Government and public broadcasting, 200 miles or more from the sea coast, exclusive, 700-750; Government and

public broadcasting, 400 miles or more from the sea coast, exclusive, 650-700; Marine radio telephony, non-exclusive, 525-650; Marine telegraphy, exclusive, 525-650; Aircraft radio telephony and telegraphy, exclusive, 500-525; Government and public broadcasting, exclusive, 485-495; Private and toll broadcasting, 285-485; Restricted special amateur radio telegraphy, non-exclusive, 310; City and State public safety broadcasting, exclusive, 275-285; Technical and training schools (shared with amateurs) 200-275; Amateur telegraphy and telephony, exclusive, 150-200 meters (this makes the total wavelength range assigned to amateurs 150-275, part of it being shared with the technical schools); Private and toll broadcasting, exclusive, 100-150; Reserved, all below 100 meters.

Of course we are principally interested in the wavelengths to be used for broadcasting. Government broadcasting is defined as that done by departments of the Federal Government; public broadcasting as that carried on by public institutions, such as Universities; presumably church broadcasting will come under this classification. Private broadcasting signifies that carried on, without charge, by any communication company, newspaper, etc. Such broadcasting, if charge is made, comes under the classification of toll broadcasting.

In view of the interest of the public, as a whole, in broadcasting, it was strongly urged that point-to-point radio communication be

discouraged; it is quite evident to any one that the use of one "channel" in the ether for conversation between two individuals is entirely out of the question unless such communication is impossible by any other means. Thus point-to-point communication by radio must be allowed only for shore-to-ship, to light-ship, or to isolated islands, etc. The granting of licenses to companies organized for commercial radio traffic between cities should not be permitted. It is to be pointed out that if such procedure had been followed during the last few years, it would not have been necessary to get out injunctions to prevent such interference as was caused by the operation of the Intercity Radio station in New York City. Such unnecessary use of radio always impedes its progress for the financial benefit of a few men more interested in their own fortunes than in that of the radio art. Wire telegraphy and telephony furnish ample means of communication for commercial traffic, in fact, it seems likely that if inquiry were made it would be found that much of the "radio" traffic of such companies is sent over lines leased from the wire companies.

HOW MANY SIMULTANEOUS BROADCASTS ARE POSSIBLE?

IT WILL be seen that for private and public broadcasting the committee recommends three bands of frequencies, rather widely separated. Public broadcasting, such as might be done by a University carrying on extension work or the free lectures sent out by city departments, have wave lengths from 1050 meters to 1500 meters; this range should permit the simultaneous transmission of about eight messages without undue interference. In estimating how many simultaneous messages are possible (or how many "channels" are available) it is assumed that the receiving set is a good one of the type using vacuum tube and regenerative connection.

For private and toll broadcasting, the band from 285 meters to 485 meters is assigned; it will be remembered that at present all private broadcasting is done on a wavelength of 360 meters. The frequency range permitted for broadcasting of this kind in which we are especially interested is therefore from about 600,000 to about 1,000,000 cycles per second, a range of 400,000 cycles. How many separate channels are there available in this frequency range? It must depend very largely upon the quality

of the receiving set used and upon the skill of the operator in adjusting it, but with the average receiving set sold to-day it seems that there may be ten or fifteen channels; if all the receivers in use were of the better types and in the hands of skilled operators, probably twenty or thirty channels would be available, but of course, such is not the case. Probably there will be not more than eight useful channels in this range of frequencies.

The question must be indeterminate to a considerable degree because of the possibility of large differences in the various signal strengths. If, for example, two stations of equal power were transmitting from New York and were being received fifty miles away, both would be of equal strength, and it would be possible to adjust the receiving sets for no interference with two wavelengths as close together perhaps as 300 and 310 meters. But if one of the transmitting stations was within a few miles of the receiving set, and the other fifty miles away, then, in order to hear the distant station without interference from the nearby station a wavelength difference of 30 meters or more would be necessary.

Private and toll broadcasting are also allowed another frequency band from 100 meters to 150 meters; although this is a comparatively narrow band, there are several channels possible because of the large difference in frequency of the two limits, namely 1,000,000 cycles. It is quite likely that there are twenty more channels available here for good receiving sets and five to ten with ordinary sets. It must be pointed out, however, that practically none of the receiving sets which have been supplied to the public so far will be much good for receiving these low wavelength signals; most of them cannot tune for a signal of such low wavelength and those that can are very inefficient for such high frequencies.

WHAT KIND OF BROADCASTING IS COMING?

IN THE range of wavelengths, 285 to 485 meters there will be about eight channels available. For what are these eight channels going to be used? We do not need to consider the possibility of broadcasting lectures or other educational talks because for such work a special frequency band has been allowed, offering, for the present at least, plenty of channels for such traffic. It appears then, that for entertainment and toll purposes there are eight channels available. This seems a lot;

at present we have only one channel, and listeners in the vicinity of New York, for example, can hear nothing but WJZ when this station is in operation. KDKA and a few others can be heard only if WJZ stops sending. With eight channels open it seems as though we should have much better entertainment in the

made, and of course that means advertising. Yet direct advertising is not to be allowed, if the recommendations of the committee are followed, as they certainly should be, in this respect at least. The toll business will probably settle down into rather good entertainment, the only advertising the client receives directly being in the wording of the announcement of the selection. Much as we may frown on the idea of radio advertising, it must be appreciated that this is just the way WJZ's excellent programme is maintained to-day. The only pay the clients of the stations (in this case the artists) get is the advertising which the announcer gives them. Of course sometimes the performances of the artists also, are of advertising value to them, but if the tubes don't function properly, they are not.

RADIO IN THE LONELY PLACES

PROBABLY the million or more people who are listening every evening to the radio entertainment which various broadcasting stations offer, are unanimous in their appreciation of this latest contribution of applied science; judged by the methods of the statistician it must indeed be a wonderful art which contributes so much enjoyment to so many people. But there are much more important fields in which radio serves, fields in which the theatre, or movie, or dance hall can contribute nothing because they are not available. Of course the real field of radio will ever be that in which Jack Binns was the pioneer, the carrying of the

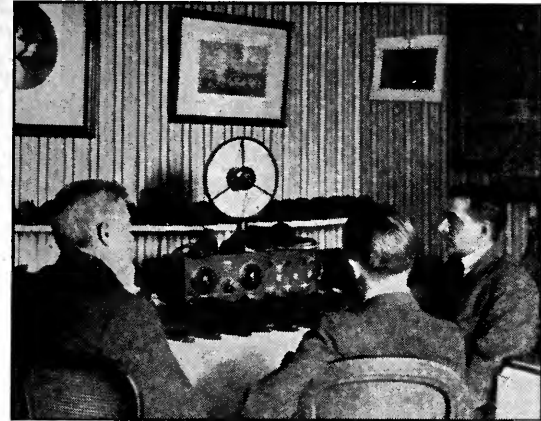

A progressive New York shoe salesman has installed a radio receiving set to entertain his customers. The large conical device is a loudspeaker made with a parchment diaphragm which reproduces music with little or no distortion

future than we have had in the past. Just what stations are going to furnish it is not yet evident, but the public may rest assured that the channels will all be spoken for soon after they are available.

Where does toll broadcasting come in? It is defined as broadcasting for which a charge is

Even in Olongapo, P. I., the U. S. Navy carries on regular radio communication, and this little shack shelters the equipment



distress call of sinking vessels, or aeroplanes stalled in inaccessible places, or adventurous explorers who have encountered difficulties which make it imperative that they get help.

Besides these cases, in which the reception of perhaps one millionth of a watt of power from the distressed operator means the difference between life and death, there are other cases where radio means the bringing to life of some people leading an existence so lonely that they are dead in so far as contact with other human beings is concerned. To the dweller on a lonely isle, perhaps in connection with the rest of the world only once a year, to the lonely watchers

on the light-houses and light-ships, for weeks and months at a time abandoned to the wind and waves, radio telephony offers something of almost inestimable value. They can now hear the voice of their fellow man perhaps every evening, and the music which travels to them so silently and swiftly must

put new life into their monotonous existences. There must be many islands on our coast where the installation of a radio outfit will bring lonely people into immediate touch with the rest of the human race. In such places, and in the light-houses and ships, radio broadcast entertainment will bring cheer and enjoyment where nothing else avails. In a recent interview, George R. Putnam, Commissioner of Lighthouses, reported that many of the lighthouses in Alaska are being equipped with radio telephone apparatus. In some of these stations, he states, the keepers have been without mail from the outside world for as much as ten months.

In hospitals a receiving outfit should be a wonderful help in keeping patients interested and comfortable. Furnished with a series of head sets, so that any patient may listen in or not, as he desires, a good receiving outfit would prove a valuable adjunct to the cheerful nurse in keeping a ward filled with smiles and contentment.

Not all of us have the vision and imagination of a Faraday, so that there are still some details of radio theory which seem more or less obscure. One of the developments of radio, which seems always to attract much attention, is the reception of radio signals by a set on a moving object, such as train, bus, aeroplane, etc. Now there is really nothing strange about this at all; in fact, it would be much more strange if signals were not received on a moving car just as well as when it is stationary.

Radio communication is carried on by means of disturbances—wave motions—in the ether;

these waves travel with the speed of light (186,000 miles per second) for the very good reason that they are really the same thing as light. If we grant that a 100-meter radio wave is the same kind of a thing as a 10,000-meter wave, then radio and light are the same thing; because of the elec-

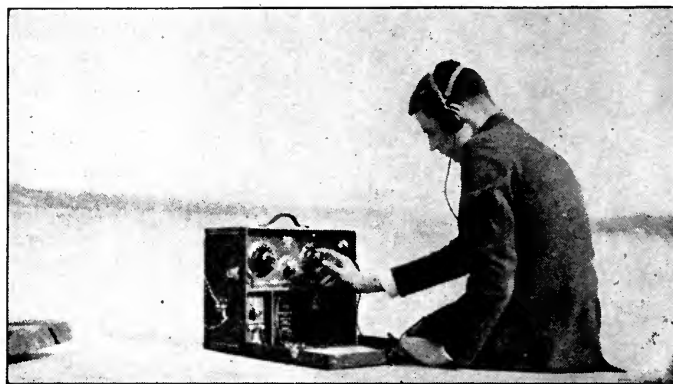

At the sea-shore or away in the mountains it is now possible to be in almost constant communication with the city. This portable radio set has a receiving range of several hundred miles and a transmitting range of four or five miles

tric and magnetic fields associated with them, they are called electromagnetic waves. When an electromagnetic wave travels by an antenna, it sets up alternating currents therein, which, acting on detector and telephones, give an audible signal. Now, will it make any difference whether the receiving station is moving or not? Radio waves being the same kind of disturbance as light waves, we may argue the question from the action of light. If a man in a passenger car, moving through a station, watches some one on the platform light a match, will the color and intensity of the flame be the same as if the car was not moving but was stationary at the platform? The flame corresponds to the transmitting station of a radio set and the observer's eye receiving the electromagnetic waves from the flame, corresponds to detector and telephone. The answer to the question is evidently—Yes, the motion of the observer does not in the least interfere with the observer's eye perceiving the

flame. Of course, if the passenger was carried past the station platform as fast, or faster, than the velocity of travel of the light wave he would never know whether the match was lighted or not; the light wave which started from the match when it was struck, would not be able to catch up with the observer, and so evidently could not affect the nerves of his eye. But trains and buses do not travel with such velocities, so we can eliminate that possibility from our discussion.

In so far as motion of the receiver is concerned, therefore, it is evident that there can be no effect on the action of radio waves; receiving a radio signal on a moving bus, or on a mile-a-minute train, is no more wonderful, from the standpoint of radio theory, than if the bus or train were stationary.

It is interesting to note that in some of the experiments in getting radio signals to moving trains, the signals were heard when the

train was in a tunnel, a hundred feet underground. Not very strong, to be sure, but still strong enough to be read. It might be said that the radio waves did not penetrate the ground so deeply but came in from the ends of the tunnel. But we also know that a submerging submarine, even after it has gone 60 feet below the surface still gets audible signals, and there are no tunnel ends for the signal to come through in such a case.

The ordinary theory of radio transmission shows that we can expect a certain amount of penetration of the radio waves into the earth or ocean; it can be predicted how far the waves will penetrate sea water, and the experiments with submarines check the theory. It's very much the same as light going through water; some will get through but most of it is absorbed before the light has penetrated the water very far; just so is the radio wave absorbed in the earth's surface.

Recent tests have proven that communication between moving trains and land stations along the route is now practical, and Edgar Sisson, Jr., is here shown operating the outfit on Lackawanna train Number 3



This absorption of radio waves gives rise to radio "shadows" such as are noticed if a high mountain intervenes between two stations. In such cases better communication is obtained if the distance between the two stations is increased, because the shadow becomes less definite, just as light shadows do in similar circumstances. An interesting case of this sort is noticed near the island of Cuba; there is a radio station on the south coast which cannot transmit reliably to ships on the north coast, there being a mountain range intervening; if, however, the vessel steams north for a hundred miles, thus getting out of the shadow, the communication is much better although the distance from the transmitting station has been more than doubled.

In a recent interview, Dr. Charles P. Steinmetz, the chief consulting engineer of the General Electric Co., is reported to have said that "under certain conditions it will be easier for wireless waves to pass through the ground than through the air. Submarines already have sent radio messages successfully while submerged, a primary substantiation of the theory, which looks to the conquering of another element in addition to the ether." If the noted engineer of Schenectady had ever listened to the signals received by a submarine as she submerges, as has the writer, and had listened to them fall off rapidly in intensity until at only a few fathoms depth they are entirely gone, only to reappear as the depth of the submarine is decreased, he would be convinced that it is much more difficult for the radio waves to travel through earth or water than through air. In fact, going through a few feet of water the signal decreases in intensity as much as it would in a hundred miles through air; this difference in behavior of air and water increases as the wavelength is made smaller.

A BETTER BROADCASTING STATION

BY THE time this is in press a new broadcasting station will be in operation, a station on the design of which probably more thought and talent has been expended than on any other in existence. It is on the top of one of New York's skyscrapers and is operated by the American Telephone and Telegraph Co.; its call will be WBAY. The actual transmitting set was designed and constructed by the engineers of the Western Electric Co., engineers who know not only engineering, theory, and practice, but who are especially trained in the

design and construction of communication apparatus.

The vacuum tubes used have oxide coated filaments, such as were employed in the detecting tubes used so extensively by the Signal Corps during the war. The larger tubes, of which there are four, are of 250 watt rating, using 1600 volts in the plate circuit. An interesting detail in the construction of these tubes is the blackening of the plates to increase the radiation of heat; a black plate will radiate much more heat, at a given temperature, than a shiny one.

A special type of microphone is to be used, the diaphragm of which is a tightly stretched, thin, steel membrane having a natural frequency far above voice frequencies. It is designed to give better reproduction of the consonant sounds than does the ordinary microphone transmitter. It is anticipated that only about 40 per cent. modulation will be employed, this comparatively weak modulation being used with the idea of keeping out the distortion of the voice sounds which occur if complete modulation is attempted.

The studio where the artists are to perform has been especially treated to reduce echoes to a minimum. The ceiling has been deadened by two inches of sound absorbing material; the floor is deadened with thick carpeting, and experiments are being made in padding the side walls with thick felt. It is the engineer's idea that practically no echo should strike the microphone; if it is actuated only by the original voice sounds, it seems that much clearer speech and music will be sent out than if echoes, from walls and ceiling, as well as the original voice, are allowed to fall on the microphone.

The absence of echoes in the room give one a strange feeling when talking; it seems as though one were talking into open space. It serves well to show how all of our senses combine to give us a certain total impression; the experience in this room convinces one at once that one's estimate of the size of the ordinary room is fixed not only by what the eye reports but also by the sound of one's voice, which, of course, will depend largely upon the echoes from walls and ceiling.

AN EXPERIMENT IN BROADCASTING

THIS A. T. and T. station is being constructed, and is to be operated, purely as an experiment. It had its inception in repeated demands upon the company for supply-

ing broadcasting transmitting sets, to be used by merchants, churches, philanthropic institutions, brokers, and what not. In all there were more than sixty such requests for apparatus, to be operated in New York City. And the Government restricts all broadcasting stations to 360 meters!

Evidently it would have been short-sighted policy to sell these equipments—the purchasers would soon find out they had white elephants on their hands. Such stations would evidently be installed for advertising, indirect, of course, but advertising nevertheless. And if a dozen of them were to operate at once they would so jam the air that none of them could be received. With the idea of avoiding this situation and further to get first hand information on the need and desirability of such broadcast advertising the A. T. and T. Co. decided to erect and operate themselves a first class sta-

tion, renting it to those firms and institutions which think they want such service; the station is to be a regular toll station where a merchant rents the privilege of using the ether for calling his wares.

Is there a demand for such a service, and, still more important, does the radio public want the ether used for such purposes? The operation of WBAY for a few months will probably furnish an answer to these questions. Whether the answer be Yes or No the operation of this station (which will have such a programme as to not interfere with WJZ) will be of benefit to the radio public because of the technical excellence of the station; the quality of transmission will probably be better than any other station now operating, so will serve as a stimulus to the others to improve the quality of their transmission to equal that of this new station.

H. M.

Submarine equipped by the Bureau of Standards, Department of Commerce, with special type of antenna for under-water radio reception and transmission

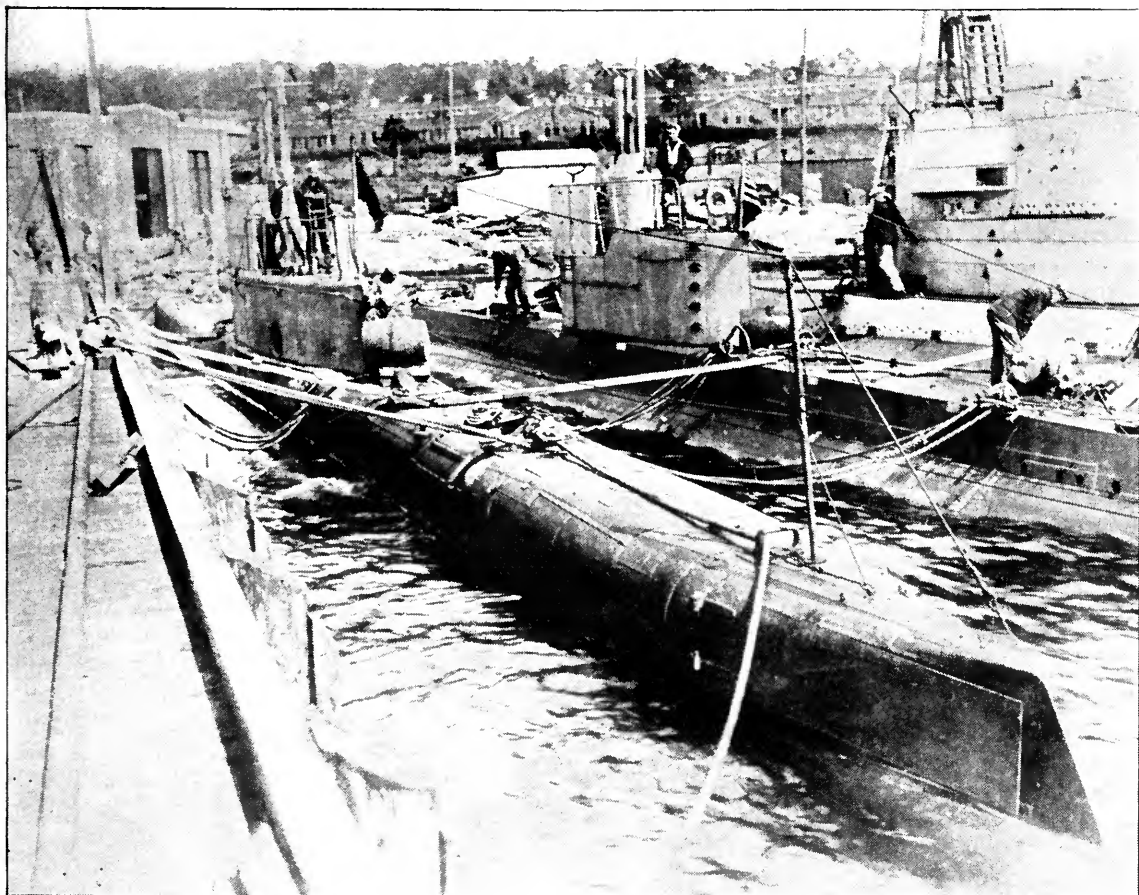

When De Wolf Hopper Broadcasted to His Biggest Audience

He Missed the Applause and Laughter and He Couldn't Gesticulate, but He Heard Later How Much He was Appreciated

SIX people had to do all the audible laughing for an audience optimistically estimated at three hundred thousand when De Wolf Hopper broadcasted his famous voice from

WJZ in Newark, N. J., recently. But the laughter proved a boon to the great comedian because he could judge by its duration just when the points of his jokes had sunk in, and it was time for him to resume his monologue.

"It was a peculiar and dramatic sensation," he said, "speaking to thousands upon thousands of people you couldn't see. I couldn't realize that so many people were hearing me. My performance lasted about twenty minutes, five and a half of which I devoted to reciting 'Casey at the Bat.' That was the hardest thing of all because I couldn't gesticulate. I had to keep my mouth about six inches

from the little drum suspended in front of me."

Mr. Hopper's mobile voice sank to a sorrowful note as he spoke of the difficulty of delivering this famous baseball recitation without the emphatic gesticulations which have delighted his audiences for more than a quarter of a century. His fists involuntarily clenched themselves.



Here is one of the famous gestures, the omission of which De Wolf Hopper lamented, when he recited "Casey at the Bat" by radiophone

"I couldn't do this," he said mournfully, "when I came to the line 'Str-r-ike out!' It was a peculiar thing, however, that I think I never recited 'Casey' better. There I was in that long narrow room, with no way to

tell whether I was pleasing my audience or not. There were only six people in the room, a gentleman and lady who had accompanied me, my son, the soloist who was to follow me, and two operators. But they all laughed a lot, and that helped me to judge how long to pause to achieve my effects. I would wait until they stopped laughing and then begin to talk again.

"I told jokes, and talked about 'Some Party,' and greeted some old friends, who had told me they would be 'listening in,' but of course, I couldn't tell how they liked it. In the days after my initial performance, however, I got millions of

letters. I remember one in particular which appealed to me. It was from two baseball fans telling me how much they appreciated 'Casey.' They wrote that they had been baseball fans all their lives, and that one of them was eighty-two and the other one was eighty-four.

"It was a strange experience at first," he concluded, "but of course I'm used to it now."

What Everyone Should Know About Radio History

By Prof. J. H. MORECROFT

PART I

AT A recent dinner attended by the writer, the principal speakers of the evening both took as their theme the complacency with which we Americans take for granted the many conveniences and comforts surrounding us, which the application of modern science has made possible. They were both foreign born, both had come to America when young, and both had achieved remarkable success scientifically and financially after adopting the United States as their new home. Both of them are endowed with keen intellects and sound judgment of men and events, which attributes no doubt contributed largely to their success, but both of them expressed the opinion later that they really saw and appreciated the advantages and opportunities of America so much more than the average American that, in the race for achievement, the native born was actually much handicapped because he took so much for granted, without inquiring how wonderful the things about him really were and how they came to be developed.

WHAT AN IMMIGRANT BOY SAW

Professor Pupin, one of our best known and most successful scientists, is fond of relating his early impressions of America; the first walk he took after landing at Castle Garden was through the lower part of New York where the streets were lined with poles carrying hundreds of telephone and telegraph wires. Having been told that signals and speech were being conveyed over these wires from city to city, scores of miles, he was filled with awe and amazement; what an opportunity there must be, he thought, in a land where such things were a part of the every day life of the people! To the native New Yorker these wire-laden poles meant nothing; he had seen them gradually installed around him, and they incited in him neither awe nor inspiration. But to young Pupin, fresh from a land of no scientific develop-

ment, they spelled all kinds of possibility and opportunity; he didn't merely take them for granted, but inquired as to how and when and where and why these speech-carrying wires came about, how they operated, and later how their operation might be improved. The inspiration he received started him on that career which brought him fame and reward and made him finally the best known scientist in the field of telephone communication.

AFTER A CENTURY OF EFFORT

An art or science is of importance to mankind in direct proportion to the benefits men derive therefrom; the appreciation of radio, and to a certain extent the pleasure arising from it, will be greatly increased by a knowledge of its principles and development. The accomplishments of the early workers, marking out the trail which was to lead to the present state of the art, make interesting reading and serve well to lay the background for discussing the work of the later scientists and inventors whose contributions are directly incorporated in the radio receiving and transmitting equipments of to-day.

Every one is now becoming more or less familiar with radio communication, and it will soon be taken for granted as much as is the telephone; to the average person the radio entertainment every evening will soon cause no more wonder or interest than do the phonograph or movies. Actually, the simple receiving set of to-day, picking up music or speech from a transmitting station many miles distant, represents the result of nearly a century of effort and development by scores of scientists and inventors; before we become too complacent in the matter, and take the radio telephone in the same matter of fact way we do the rest of our applied science miracles, it is worth while to review their labors and progress, as a knowledge of their work will make the evening's radio concert the more pleasurable

and appreciated. It is with this idea in mind that the following brief story of the wireless telegraph has been written.

The earlier name for communication between two stations without the use of connecting wires was the wireless telegraph, but for reasons to be shortly pointed out the term radio telegraph or radio communication is now generally used and preferred. There are three closely allied developments in the growth of the radio of to-day, all of which contributed their share toward our knowledge of the art. The first has to do with the early attempts to carry on ordinary telegraph communication without wires, the earth's surface forming the conducting medium between the two stations. A great deal of work was done in this field by many workers; the reward for a successful solution would have been great as it might have made unnecessary, to some extent, the very expensive cables being installed for transoceanic telegraphy. This scheme of using the earth for conductor found application during the war just past for communication from the front line trenches and is well known to those acquainted with the work of the Signal Corps, where it goes by the abbreviation of its French name, T.P.S. (Telegraphie Par Sol).

THEN THE IDEA OF INDUCTION WAS TRIED

A second line of work used no conducting medium whatsoever between the two stations; comparatively slow change of current in one coil was used to induce currents in another coil in the vicinity and these induced currents, by some prearranged code, were used to convey information. This work was begun in England and the United States at about the same time, by independent workers; it did not apparently promise much success at the time, but with our present knowledge of the art it seems that some of the experimenters missed the real solution of the problem by a very narrow margin. This scheme has recently received much public notice because of its application to the guiding of vessels into a harbor during the night or in a fog, when ordinary methods of navigation are not available. In this method of navigation, a cable laid in the channel is traversed by alternating current and coils placed on the sides of the vessel's hull receive induced currents from the cable and the navigator can maneuver his vessel by the relative strengths of the signals received on the two sides.

The third line of work involved the same gen-

eral idea as the foregoing, but the changes of current were thousands of times as rapid as those formerly used; instead of using the ordinary phenomena of induction, as explained by Faraday and Henry, a new concept of *radiated power* was invoked and with this step taken, success was assured. As long as the communication between the two stations depended upon the induction ideas of Faraday and Henry the possible separation of the two stations was but a few times the dimensions of the coils used at the stations; when high frequency radiated power was utilized, the possible distance of communication was increased thousands of times and made feasible the transmission of signals between any two points located upon the surface of the earth.

THE FIRST EXPERIMENTS BY STEINHEIL

In 1837 Professor Steinheil, of Munich, while making some experiments with the telegraph apparatus ordinarily using two wires, one for the outgoing current and another for the return, found that it was possible to dispense with one of the two wires hitherto thought necessary, and use only one wire. This one wire was connected, at the transmitting end through battery and key, to large plates buried in the earth and at the receiving end it was similarly connected to ground through whatever type of receiving apparatus was used. He thus showed that the ordinary one wire telegraph system of to-day, using the earth as the return was possible. This experience evidently aroused Steinheil's imagination, as he suggested, in 1838, when discussing the results of his experiments, that it might be possible to carry on communication with no connecting wires at all between the two stations!

PROFESSOR MORSE'S WIRELESS

In 1842, Professor Morse in America, actually did establish telegraphic communication between two stations on the opposite banks of a river, there being no wires at all crossing the river. Along one bank of the river he laid a wire in which were contained his sending battery and key; this wire terminated in two metal plates placed in the river itself. These plates were separated from each other by a distance greater than the width of the river. A similar wire and set of plates was used on the opposite side of the river, the plates on one bank being opposite those on the other. The receiving galvanometer was inserted in series with this

second wire. When the sending switch was closed it sent current through the river water from one plate on the sending bank to the other. The current spread throughout the river and some of it strayed to the opposite bank, flowing through the opposite plates and wire and thus through the receiving instrument. Although but a small part of the current reached the opposite bank it was sufficient to actuate the galvanometer used for receiving, and thus *wireless telegraphy was an accomplished fact*. It may be noted that quite long wires were necessary on the two banks of the stream so it could not logically be called wireless communication, but it must be remembered that such is always the fact with our present radio stations. In a modern radio trans-Atlantic station the sending antenna may contain 50 miles of wire in the overhead net work and perhaps even more buried underground. The essential point in wireless communication is that there must be no wires connecting one station with the other.

BRITISH SCIENTISTS WHO CONTRIBUTED

In 1859, in Dundee, Lindsay was working along the same lines that Morse had followed, apparently unacquainted with Morse's experiments. He made many tests and endeavored to find the laws of transmission distance in terms of the size of plates used, length of land wires, size of galvanometer coil, etc. He came to the conclusion that if two plates were immersed in the ocean, one off the most northerly part of Scotland and the other off the southern coast of England, if a powerful set of batteries was used for sending, and if a galvanometer coil weighing two hundred pounds were used at the receiving station, it would be possible to send messages from England to America through the ocean water. We know now that the laws he deduced were not quite correct and that such a scheme is

not feasible. The idea of a receiving coil weighing two hundred pounds is interesting when we consider that the coil of the galvanometer actually used to-day weighs less than an ounce.

In 1845 Wilkins, in England, suggested that Morse's scheme be used in establishing wireless communication with France, across the English Channel, the same feat that was to make Marconi famous fifty years later, using a different and more effective form of transmission.

Many more experimenters than the few mentioned here worked in this field, endeavoring to eliminate the connecting wire between

the two stations, among them Professor Trowbridge, of Harvard. He reached the conclusion that trans-Atlantic communication by Morse's scheme might be possible if the two plates to be submerged in the ocean were as far apart as are Nova Scotia and Florida. The wire thus required to connect the two plates would be as long as the distance to be traversed, a statement which gives the approximate range for this type of wireless transmission. The laws of the spreading of current were better known to Trowbridge than they were to Lind-



MICHAEL I. PUPIN

say when he first put out his project, and furthermore the telephone receiver had been invented in the mean time which gave to the scheme a receiver much more sensitive than anticipated by Lindsay.

Trowbridge also put forth the quite feasible scheme of fitting a ship with submerged plates in bow and stern (or bow plate and a trailing insulated wire astern, carrying the second plate at its end) and sending out into the ocean an interrupted current which would spread out all around the ship; another ship similarly equipped with plates and a telephone receiver for listening, would be able to detect the presence of the first ship, thus rendering collision in case of fog much less likely. If the

present scheme of radio communication had not come into the field, it seems likely that Trowbridge's scheme would have been universally adopted. If the trailing wire should be one quarter of a mile long, a second ship would be able to detect the presence of the first at a distance of about one half a mile and this would evidently give sufficient warning to prevent collision.

ALEXANDER GRAHAM BELL'S EXPERIMENTS

In 1882 Alexander Graham Bell tried out the scheme of using two charged metal plates immersed in water for communication. Using boats with a submerged plate at the bow and the second plate at the end of a trailing wire one hundred feet long, using interrupted current in one boat and the telephone receiver for the detector in the other, he was able to get signals when the boats were separated about one half a mile. This possible distance will be much less when the boats are in salt water than when in the fresh water of a river, however.

In the T. P. S. scheme of the army, two iron stakes are driven into the earth at a separation as great as feasible; a powerful buzzer, with battery and key, is placed in series with the wire which connects these two stakes. If two other stakes are driven into the ground some distance behind the front line trench where the first pair of stakes is driven, and this second pair of stakes is connected by a wire in series with which is a sensitive telephone receiver, the system forms a possible communication link from a position where other types of communication are impossible.

HOW MODERN RADIO DIFFERS

It is to be noticed that in the schemes of communication so far described the sending and receiving stations each connect two points on the earth's surface and the transmitting and receiving apparatus are connected between these two points; low frequency currents are caused to traverse the earth's surface and a small part of the transmitted current reaches the surface where the receiving points are located. This is true wireless telegraphy, as much so as the type used to-day for radio broadcasting, and the two methods have many points in common. The line connecting the two contact points at the receiving station should be essentially parallel to the similar line at the transmitting station; the transmitted power is sent in all directions in both schemes so that but a

very small fraction of the transmitted power is actually received. In the modern radio scheme each station uses two points in a similar manner, but one of them is on the earth's surface and the *other is up in the air*. The transmitting and receiving antennae should both be vertical, that is, parallel to each other as in the foregoing schemes. The essential difference of the two schemes lies in the frequency of current used in the transmitting antenna, and the factor of height of the two stations.

THE IDEA OF MUTUAL INDUCTION

A second possible method of wireless communication was opened up when the laws of electro-magnetic induction, discovered independently by Faraday in England and Henry in America, were made known. When a current flows through a coil, a magnetic field is set up in the space surrounding the coil. When the current in the coil is varied, the magnetic field will correspondingly vary, and if another coil is placed in proximity to the first, and so situated in the magnetic field, the changing magnetic field will set up a voltage in the second coil and if this is connected to some detecting device (such as a telephone or galvanometer) any change of current in the first will be recorded in the second. In this method real wireless communication is possible, there being no connection to the earth at either station. The amount of current which can be set up in the second coil by the changing current in the first decreases very rapidly with increasing distance between the two coils, so much so that the scheme is useful over only small distances. Thus if we have two coils say ten feet in diameter, the possible distance of communication would be probably less than two hundred feet.

Remarkable as was the discovery of electro-magnetic induction it contributed but little directly to the problem of wireless transmission of signals over appreciable distances; it is of course used throughout the transmitting and receiving sets wherever two circuits are coupled together magnetically, but in so far as the actual transmission of the power is concerned it gave but little promise. In 1891, however, Trowbridge suggested an interesting use of this principle, which, had it come about, would have much resembled a modern radio installation. His idea involved the installation of large coils in the rigging of a ship, these coils to be as large as could be carried from the ship's spars. If the current in the coil of one

ship should be interrupted many times a second, a telephone receiver connected to the coil of a neighboring ship would receive a signal and so permit the transmission of messages. Trowbridge further pointed out that such coils would permit the determination of the relative direction of the two ships from each other, a rôle filled to-day by the radio compass.

DOLBEAR, EDISON, AND STEVENSON

In 1883 Dolbear described his scheme for wireless signaling in which he used at each station an elevated wire, grounded on only one end; he was able to get communication over a distance of half a mile and some of his notes on the working of his scheme indicate that he was very close to a real solution of the problem.

In 1885 Edison and his associates devised a scheme for signaling to moving trains by induction from the telegraph wires running parallel to the railroad tracks. The currents induced in the train receiving apparatus were received with the train at high speed and the system had the advantage that the same wires could be used simultaneously for regular telegraph traffic. In Edison's apparatus the currents had to "jump" from the telegraph wires to the train, a distance of thirty to forty feet; it was evidently to this extent a system of wireless telegraphy.

The most remarkable achievement using the principle of magnetic induction was accomplished by Stevenson in England in 1892; he was able to establish reliable communication from the mainland to an island half a mile distant, using at his two stations large horizontal coils two hundred yards in diameter. In the transmitting coil the current from a few cells

was interrupted by scratching a contact on a file and in the receiving coil a telephone receiver was used for detecting the induced currents.

WHY "WIRELESS" CHANGED TO "RADIO"

We have now come to the point in the development of wireless communication where the really important work begins; it is worth while to review what had been done in the rather more than half century which had elapsed since Steinheil had used the earth for one of the conductors of his telegraph system

and had then put forth the proposition to do away completely with any wire connecting the two stations communicating with each other. A host of experimenters had worked on Steinheil's idea of using the earth or water as the only connection between the two stations, with some success, the most promising being the work of Bell; the feasible distance of communication by this scheme, however, seemed to be sharply limited to a few miles at most. Electrostatic as well as electromagnetic induction had both had their adherents, and considerable success had rewarded their efforts as evidenced by Edison's telegraphy with moving trains and Stevenson's transmission

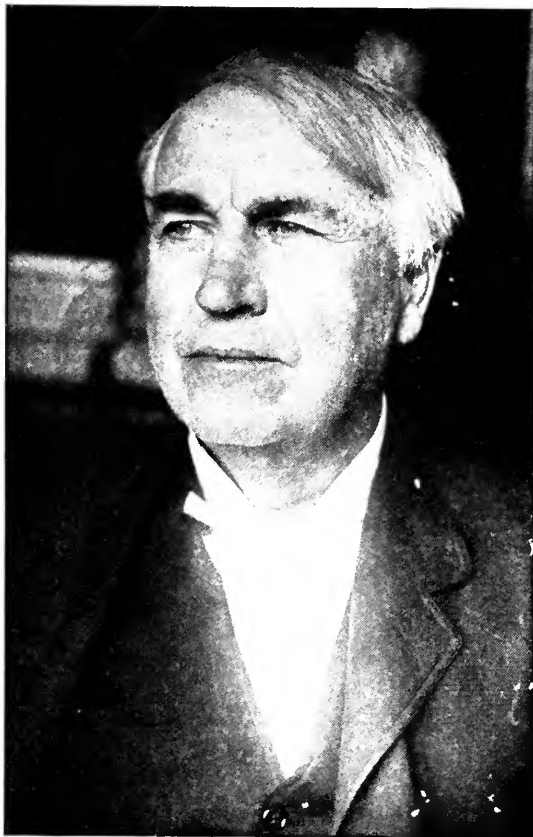

THOMAS A. EDISON

from mainland to island. The promise of much greater distance was rather slight with all of these schemes, however, and the time was ripe for the introduction of some new and radical step in the problem.

This new step was rapidly forthcoming; the energy radiated by very high frequency alternating currents and some simple scheme for detecting the high frequency currents, were the new concepts which were to give the development the wonderful progress which it

so soon showed. Incidentally, the new idea of using radiated energy, as contrasted to the previous schemes, gives us the reason for the change of name from *wireless* telegraphy, up to now a proper name for the art, to that of *radio* communication, indicating that the power used in carrying the message was not due to conduction through the earth's surface, or to magnetic induction, but to energy which was actually shaken free from the transmitting station antenna, and left to travel freely in all directions.

MAXWELL'S THEORY OF RADIATED POWER

The theoretical work of Clerk Maxwell carried out during the period from 1860 to 1870 and published in complete form in 1873 showed that energy may be radiated from an electric circuit and that this energy shaken free from the circuit follows the same laws as does ordinary light. In fact, Maxwell made light and radiated electric energy exactly the same kind of a disturbance in the universal ether, Maxwell had, of course, no idea of the usefulness of this startling concept; he was a scientist, of the pure kind as contrasted to the applied, and his work was done in the spirit of pure science. It was the truth regarding certain natural phenomena as he saw it, and it is in the pursuit of the truth about Nature's activities that men like Maxwell pass their lives. Their material reward is generally nil, but that matters to them not at all; the joy of finding out the secrets of nature is the only reward required to keep them stimulated for further work. We shall point out later the work of another pure scientist who predicted theoretically that the modern vacuum tube was possible; others made the tubes and reaped the financial reward. To those buying the tubes to-day it undoubtedly seems that they are still reaping their reward.

Maxwell's theory of radiated power was the subject of much scientific argument and discussion; for many years this theory lacked any experimental evidence, either for or against it. The English scientists in general adopted the theory, but those of the continent were against it as being more complex and difficult to understand than the older theories of light and electricity. At the suggestion of von Helmholtz, probably the best known of German physicists, Heinrich Hertz was persuaded to take up the problem of connecting experimentally the behavior of light and electromagnetic waves. Hertz had almost given up

the idea of carrying out this experiment when he noticed a peculiar event taking place in another experiment he was working on. He was discharging a condenser through a spiral inductance coil, when he noticed that another coil in the vicinity produced small sparks every time the discharge took place in the first circuit. This phenomenon is the same as takes place every time a spark transmitter is operated to-day; the current in the antenna of a spark set is excited by the oscillatory discharge in the so-called local circuit.

AN ACCIDENT STARTED HERTZ

The sparks in the second coil took place with such regularity that Hertz decided to investigate their action. It will be noticed that this beginning of Hertz's remarkable work was the result of accident; if the second coil had not been in the neighborhood of the first when the discharges were taking place, no spark would have been noticed in the second and probably nothing further on the problem would have been done by Hertz and some one else might have carried out his epoch-making work; in fact, Professor Oliver Lodge, in England, would have been almost sure to have carried out the work if Hertz had not started when he did.

Hertz's own report of his brilliant and important experiments is available, as the original papers of Hertz have been translated into English and published under the title of "Electric Waves"; for the most part the book is non-mathematical and makes very interesting reading. As Hertz felt his way in this new field his reports had all the fascination of those of the explorer of unknown lands. His various papers followed one another so rapidly that in the space of only two years, 1887-1889, he had covered practically the whole field and had established firmly the laws of electric wave propagation as we know them to-day. He showed that the waves sent off from an electric circuit carrying high frequency current traveled with the same velocity as does light, that these waves could be reflected by mirrors and refracted by prisms and lenses just the same as light. He measured the length of the waves with which he was experimenting, and found that his detecting circuit must be of the same natural frequency as the transmitter if the response was to be appreciable. As one reads the account of these experiments he feels that Hertz's laboratory was really the birthplace of

the radio art and cannot help feeling regret that this keen experimenter could not live long enough to see the wonderful practical benefits which mankind was to receive as the direct result of his work, carried out in the interest of pure science. It is because of the results following from the work of such men as Hertz that our most highly developed industries are to-day spending millions of dollars annually in the support of purely scientific research; the directors of these immense laboratories know too well that no real scientific truth can be discovered without bringing with it some application which will benefit the industry itself.

Very shortly after the death of Hertz in 1894 the world began to hear of the modest successes of Marconi, whose optimism and aggressiveness, combined with the wonderful foundation of knowledge which Hertz had given, soon showed that the possible reliable distance of radio communication was probably limited only by the extent of the earth's surface. In our next number will be taken up the work of the later and better known inventors and scientists, Marconi, Fleming, De Forest, Fessenden, Armstrong and others, who, building on the work of those earlier experimenters we have mentioned in this number, have given us the modern radio telephone.

An Evening with Dr. Alexander Graham Bell

By DONALD WILHELM

WE TELEPHONED to Dr. Bell shortly after dinner. We, the managing editor of the *World's Work* and I, wished, if possible, to see him.

his secretary was told, if he felt physically able to see us.

Back came the inquiry a bit later "What time would you like to come, to-night?"

"To-night?"

"O yes. Doctor Bell often receives callers at night. He says that he will be glad to see you at any time up until two or three o'clock in the morning!"

At our end, we reckoned that there must be something wrong with the line! We considered that Doctor Bell was twenty-nine years of age when he invented the telephone in 1876, must therefore be in his seventy-fifth year! Being, ourselves, in the thirties, we felt that 9:30 would be late enough for us.

At 9:30 Doctor Bell arose from his family group, a figure as nearly majestic as the figure of a man ever comes to be; a veritable oak of a man; a tall man finely put together, in a light gray suit, with a skin tanned by the out-of-doors, and eye as clear and blue and rested as that of a young man. His white copious hair was flung back. A curved pipe hung in a per-

fectly steady hand. He wore neither glasses nor spectacles. I glanced at his hands. There was not a tell-tale mark of age on them. Later, when he snatched a paper pad from a handy table and with pipe dangling from his mouth and both hands and arms unsupported he drew a diagram, we could not discern the suggestion of a tremble. I confess that I wrote down in my notebook then and there just this: "Think what this man has done for the world! The hazards of Science are great enough, but where, except in the world of Science, can a man give his life for the millions yet conserve it still!"

"Light up," he laughed, settling himself in his chair. "Will you have a cigar or a cigarette—O you prefer your own brands? That's fine! I like to pull on this old pipe."

It was all like an idyl. Here was a man who, within the span of a lifetime, had seen his dreams come true; who had topped the mountain, held his ground, who says he never felt stronger intellectually. "My mind has a greater power of concentration," he observes when you ask him, "than it ever had. It seems to be quicker and it does not tire along the line in which I am interested. I sometimes work for eighteen hours at a stretch." And "by the by," to use his phrase, you are privileged to go along hand-in-hand with him down

through his long life, in turning the pages of his Recorder. There are whole volumes—a score of them, each of 500 pages or so—with records of his daily researches, experiments, speculations, all packed with the bounty of an intellectual life in a variety that is incredible. In these volumes, in fact, you find his tremendous energies devoted to the telephone, to kites and aircraft and the scientific breeding of sheep, to the utilization of waste heat, the need of a new acceptance of a metric system, experiments in preserving food, notes on eugenics and *The Biologic History of a Cat*; oral teaching, a paper on the utility of action and gesture, observations on lip reading, on Hertzian waves, and, among a hundred other subjects, not to mention many pages devoted to glorifying Life in general, his description of his early experiments in transmitting wireless signals through the earth's crust and through the waters of the Potomac. Also, most interestingly, you find his papers on the first of all wireless telephones—the photophone, the light phone.

About this first wireless telephone, which of course did not, like the modern radiophone, use a tuned circuit, we wished Doctor Bell to talk; also about his early experiments in detecting and transmitting signals, and the first use of the telephone therefor, without the use of wires. And of course we yearned to have him discuss his invention of the original telephone, and that momentous day, that birth-day of both wire and radio telephonic communication, March 10, 1876. For, clearly, without the use of some instrument as sensitive as the Bell telephone, even Marconi could not have revealed the enormous possibilities of the wireless.

The year 1871 found Doctor Bell, at the age of twenty-four, teaching vocal physiology in Boston University. By the by he established his own school, applied his own system of teaching the deaf, and went to live in the home of five-year-old George Sanders, one of his pupils, in Salem. In the Sanders cellar he set to work with tuning-forks, magnets, batteries. For three years he worked. In 1874 he had evolved what he called the harmonic telegraph—a device for sending a number of Morse messages over a single wire at the same time by utilizing the law of sympathetic vibration. That is important because, in seeking to develop it, and to perfect its transmitter and re-

ceiver, electromagnet, and its flattened piece of steel clock spring, he met Thomas A. Watson, and on June 2, 1875, after months of countless experiments, profited by an accident, one of those accidents that have contributed a vast deal to Science. One of the transmitter springs stuck. The magnetized steel generated a current that sent a faint sound over the electric wire to his receiver. Then he knew that his supreme dream of telephonic speech was within the realm of possibility. So, with his principles established, he went to work on his telephone.

On March 10, 1876, the birth-date of the telephone, he applied these principles for the first time successfully. In that attic room of his, at the end of a hundred feet of wire, he put his mouth to his telephone and said, "Mr. Watson, come here, I want you." Watson came rushing through the intervening door shouting, "I heard you; I could hear what you said!"

Doctor Bell likes to add, by the by, some of the singular incidents that followed. "The Japanese language was the first language, after the English, used over the telephone," he said. "I had two Japanese students. One of them asked me if the telephone would speak Japanese. I told them to try."

On October 9, 1876, over a telegraph line between Cambridge and Boston, Doctor Bell and Mr. Watson held the first telephone conversation over a considerable distance. Soon thereafter the *Boston Globe* transmitted the first press report, from Salem, Massachusetts, to Boston, by telephone. Still, people were incredulous. Thus Mr. Bell was invited to display his instrument at the Philadelphia Centennial. But there, in his remote corner, he attracted little attention until the Emperor of Brazil, Dom Pedro, took up the receiver to listen, at the far end of a large room, to the voice of the inventor. He exclaimed, dropping the receiver suddenly, "My God, it speaks!" That was an event which caught popular fancy; still, it was not until sixteen months after Doctor Bell had filed his patent, he says, when there were already 778 telephones in use, that, in August, 1877, The Bell Telephone Association, the first telephone company ever established, was formed. It had no capital at the outset. It had four members only—Doctor Bell, Gardiner G. Hubbard, Mr. Watson, and Thomas Sanders, Georgie's father, who furnished all the financial backing.



But Doctor Bell was not interested in business. "It has always been that way," he told me. "After I have made a discovery and got it under way my interest in it lessens." Hardly, in fact, had Theodore N. Vail and his associates set about to make the telephone a universal servant when the inventor himself struck off into new fields.

It was, as accurately as the date can at present be fixed, toward the end of the year, 1876, in which he invented the telephone, that Mr. Bell, for the first time, used the phone, instead of a galvanometer, to experiment with and to trace out the lines of the earth's potential. In these experiments,

incidentally, he used a steel-band telephone, as it was then called, to clasp the phone to his ears, leaving his hands free—the first time the helmet telephone receiver was ever used. "Using two metal exploring rods—they were really stove poker," he explained, "I set to work on Mr. Hubbard's place



©Underwood & Underwood
Alexander Graham Bell, finding his own invention a source of annoyance, had it removed from his room in favor of a radio receiver. Mr. Bell is now 75 years old and an ardent radio enthusiast

on the outskirts of Cambridge. I drove the rods into the ground. At the receiving rod I found that upon listening with the telephone I could hear a clock ticking. I then noted that at periodic intervals the clock would miss a tick. By means of that irregularity I was able to identify the clock as the time clock of the Cambridge Observatory, a half mile away. There was, I knew, a telegraph line from the Observatory to Boston, to pass the time. Using ground that was charged, with the Observatory as the centre of an imaginary circle, I was able to define concentric circles that indicated much more accurately than had been possible with a galvanometer, the lines of potential. In other words, if both of the rods were in a part of the charged ground that was to be designated as concentric circle 9, closest to the Observatory, both ends of my earth telephone circuit had the same potential, but if one were in 9 and another in 8, there would be a residual effect and I would get a sound."

Later he carried these experiments on in a different direction. "First, in a vessel of water," he said, "I placed a sheet of paper. At two points of that paper were fastened two ordinary sewing needles, which were also connected with an interrupter that interrupted the circuit about 100 times a second. Then I had two needles connected with a telephone: one needle I fastened on the paper in the water, and the moment I placed the other needle in the water I heard a musical sound from the telephone. By moving the needle around in the water, I would strike a place where there would be no sound heard. This would be

where the electric tension was the same as in the needle; and by experimenting in the water you could trace out with perfect ease an equipotential line around one of the poles in the water."

In July, 1877, Mr. Bell married Miss Hubbard. They went to London on their honeymoon. In London he made

the classic speech on the telephone and explained and demonstrated the experiments described above to William Preece, the head of the British Post Office system, who was vastly helpful to Marconi, and others. He also experimented across the Thames. "On one side," he said, "I placed two metal plates at a distance from each other, and on the other two terminals connected with the telephone. A current was established in the telephone each time a current was established through the galvanic circuit on the opposite side, and if that current was rapidly interrupted, you would get a musical tone."

On his return to America he discussed these experiments before the American Academy of Arts and Sciences in Boston, on December 11, 1878. He described his experiments, which he proceeded to develop on the Potomac.

"In the experiments on the Potomac," he said, "I had two boats. In one boat we had a Leclanché battery of six elements and an interrupter for interrupting the current very

rapidly. Over the bow of the boat we made water connection by a metallic plate, and behind the boat we trailed an insulated wire, with a float at the end carrying a metallic plate so as to bring these two terminals about 100 feet apart. I then took another boat and sailed off. In this boat we had the same arrangement, but with a telephone in the circuit. In the first boat, which was moored, I kept a man making signals; and when my boat was near his I would hear those signals very well—a musical tone, something of this kind: tum, tum, tum. I then rowed my boat down the river and at a distance of a mile and a quarter, which was the furthest distance I tried, I could still distinguish those signals."

He added, in our discussion, that one of the boats that he used was near Chain Bridge while his own boat was, at the conclusion of the experiments, at the Washington Monument. And at the time of his experiments he pointed out the practicability, since "most of the passenger steamships have dynamo engines and are electrically lighted," of each vessel trailing a wire a mile or so long duly charged, and attached to a telephone. "Then," he said, "your dynamo or telephone end would be positive and the other end of the wire trailing behind would be negative. All of the water about the ship will be positive within a circle whose radius is one-half the length of the wire. All of the water about the trailing end will be negative within a circle whose radius is the other half of the wire. . . . It will be impossible for any ship or object to approach within the water so charged in relation to your ship without the telephone telling the whole story to the listening ear. Now, if a ship coming in this area also has a similar apparatus, the two vessels can communicate with each other by their telephone. If they are enveloped in a fog, they can keep out of each other's way. The matter is so simple that I hope our ocean steamships will experiment with it."

It is only to be added that these land and water experiments of Doctor Bell without question were factors in the success of Mr.—later Sir—William Preece in England. His first experiment was made in 1882. In that year in a public address, he said, "The discovery of the telephone has made us acquainted with many strange phenomena. It has enabled us, amongst other things, to establish beyond a

doubt the fact that electric currents actually traverse the earth's crust. The theory that the earth acts as a great reservoir for electricity may be placed in the physicist's wastebasket. . . . Telephones have been fixed upon a wire passing from the ground floor to the top of a large building (the gas pipes being used in place of a return wire), and Morse signals, sent from a telegraph office 250 yards distant, have been distinctly read. There are several cases on record of telephone circuits miles away from any telegraph wires,

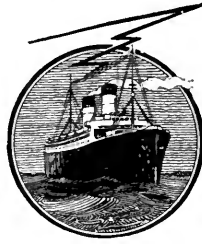

but in a line with the earth terminals, picking up telegraphic signals; and when an electric-light system uses the earth, it is stoppage to all telephonic communication in its neighborhood." Mr. Preece then describes one of the first of all his experiments, which was made, it is to be noted, nearly five years after those described above of Doctor Bell. Sim-

ply, this experiment, in March, 1882, successfully linked up the Isle of Wight with Southampton when the cable between that island and Southampton broke down. His complete circuit, including the water, started from Southampton, ran to Southsea Pier, 28 miles; across the sea, 6 miles; Ryde through Newport to Sconce Point, 20 miles; across the water again, $1\frac{1}{3}$ mile, thence from Hurst Castle back to Southampton, twenty-four miles. "With a buzzer, a Morse key, and 30 Leclanché cells at Southampton," he says, "it was quite possible to hear the Morse signals in a telephone at Newport, and vice versa. Next day the cable was repaired, so that further experiment was unnecessary."

Since those early days, while on one hand it becomes more and more apparent that the radio art would have been infinitely harassed in its origin and development without the telephone, it has also become apparent that the relationship of earth characteristics and those of the sea, must sooner or later have been given just such attention as Doctor Bell gave, and encouraged others to give, to them. There is good ground for saying that these experiments fathered many perfections in earth telegraphy, including the TPS work used in the main during the war by both the Allies and the Germans for intercepting messages, notably telephone messages. But, it is also to be noted that ground methods do not permit of the use of high frequencies, do not employ tuned cir-

cuits, and do not belong, in the view of many authorities, within the sphere of modern radio.

Nevertheless—the proof is in of Mr. Bell's amazing ingenuity and resourcefulness—it may well be that his experiments with ground and water telegraphy and telephony might long ago have given results that have not even now been attained if he had continued his experiments. But his fertile brain got to working in other directions, at aircraft, for instance.

We have seen how, on March 10, 1876, he spoke the first words ever sent over a telephone line.

Four years later, on Sunday, February 15, 1880—he remembers the date because on that day his daughter, now Mrs. Fairchild, was born—he received the first words ever spoken over a wireless phone. The words spoken and received were heralded by a flash of light through his laboratory window. Then he distinctly heard, he told me: “Mr. Bell, Mr. Bell, if you hear me, come to the window and wave your hat!”

The man who spoke these words was Charles Sumner Taintor. He was on the top of the Franklin School, 13th and K Streets, N.W., Washington. Mr. Bell was in his laboratory on L Street, between 13th and 14th, on the north side of the street. Curiously enough, it should also be added, though Maxwell and others abroad, in the years around 1880, were suggesting and even assuming a medium through which electromagnetic action could be propagated, Hertz, who demonstrated conclusively the existence of that medium and related electromagnetic or “Hertzian” waves and light waves, did not begin to produce his tremendous series of papers until 1888. Yet the instrument devised by Doctor Bell, by which for the first time in history words were transmitted beyond the power of the human voice and without the use of wires, might have been called a light-phone, was at both the Louisiana Purchase Exposition and the World's Fair displayed as the radiophone, and without question projected speech on electromagnetic waves, though not, of course, by means of high frequencies or a modern tuned circuit.

“For some time,” Mr. Bell told me, “we had been carrying on experiments between the top of the Franklin School and the Virginia Hills, a mile and a half away. These experiments

had progressed until we succeeded with them that Sunday when my daughter was born.”

He smiled. “Looking back,” he considered, “I was very nearly not at home!”

He related, then, how, when his experiments had proven a success, he put all the records into a sealed envelope and deposited the envelope in the Smithsonian Institution, where, unopened, the envelope still remains. That fact leaked out. Shortly thereafter a gentleman named H. E. Lix, of Bethlehem, Pennsylvania, gave out the information that he had invented a method of seeing by telegraph.

The two ideas of an invention by this unheard-of inventor and the mystery of the sealed envelope became confounded in public prints with the remarkable result that two English inventors assailed Doctor Bell for seizing upon their ideas concerning an instrument by which one could see by telegraph!

But Doctor Bell, himself, had nothing to say, for, by contract, all his inventions of that period automatically became the property of the American Bell Telephone Companies.

Briefly, Mr. Bell had noted the remarkable characteristics of selenium, which, Willoughby Smith in 1873 had demonstrated, would, if placed in an electric circuit, alter its resistance to the current under the influence of light of rapidly varying intensity. With this cue Mr. Bell developed a mirror in the shape of a telephone diaphragm—a mirror of minimum thickness. Fastened to this mirror was a mouth-piece. When one spoke through this mouth-piece the mirror vibrated. He then devised means to throw a beam of light against this mirror and, by reflection, to direct this beam to the receiving apparatus. Bit by bit he then developed improvements so that the mirror in its vibrations caused fluctuations (invisible fluctuations, of course) in the light rays and corresponding variations in the degree of heat in the amount of light thrown upon the substance designed to reproduce the sounds of the voice. For instance, the word “Hello,” which makes changes in a modern electrical circuit distinctly different, after being spoken into a telephone, from those made by the word “good-by”, caused certain vibrations in the mirror. These in turn caused fluctuations in the rays of light, and the receiving apparatus, under their influence, sent out sounds which reproduced the word, “Hello.” For receiving, he



used selenium in an electric circuit with a telephone receiver, and, also vegetable fibre or lampblack placed in a glass bulb from which rubber tubes led to earpieces. On these substances (later it was demonstrated that many others could be used, such as a bit of black worsted cloth, of silk, or particles of rubber) the action of the rapidly varying degree of heat in the light rays caused the substances in the bulb to expel and absorb gases, alternately. These gases in turn produced vibrations in the air in the tubes and these vibrations made themselves felt in the eardrums of the person listening, causing an exact reproduction of the words spoken at the transmitter.

The instrument worked, and stood the test of many demonstrations. In the laboratories of the Bell Telephone Companies and later in those of the American Telephone & Telegraph Company, it was developed. There arc lights came to be used along with many other variations in Mr. Bell's original device. Thus in April, 1897, Hammond B. Hayes, one of the engineers of the American Telephone & Telegraph Company, noticed that a humming sound, audible in the receiver of the "radio-telephone," corresponded in pitch with that produced by the generator supplying the current for the arc lamp used in the experiments. Starting with this discovery Mr. Hayes concluded that if the words spoken into a telephone were made to act directly upon the lighting circuit, it would not be necessary to use the mirror employed by Mr. Bell and the distance which speech could be transmitted would be greatly increased. In other words, the telephone current could be superimposed upon the lighting current. This was done by attaching the telephone wires to the wires in the arc light. The principles remained the same, but with the improved device, which was patented in June, 1897, the sound of the voice could be heard with distinctness at points several miles from the transmitter, and it was known that good results might have been had at much greater distance.

The instrument, as it now stands, is simple in appearance. The receiver used consists of a selenium cell enclosed in a glass bulb no bigger than that in which the homeopathic physician carries his pills. In making the cell, very fine brass wires are wound upon a bit of Indian pipe stone. The wires are then covered with

a thin layer of selenium and are attached to the wires which connect with the telephone receiver. The glass bulb is then placed in a reflector which concentrates the rays of the lamp upon the selenium.

At the sending end a searchlight such as is used on vessels is used. From the telephone transmitter, which is of special construction, wires lead to the lamp, and are attached to the wires which carry the lighting current. When words are spoken into the transmitter, the rays of the searchlight fluctuate. Standing by the lamp, however, an observer sees no change, of course. At the receiving end, which may be miles beyond visual distance by the naked eye, the selenium responds to these fluctuations in the light rays and the current in the wires there increases and diminishes in thousands of infinitesimal changes which reproduce not only the spoken words but the very tones of the voice of the speaker.

The possibilities of the instrument, even though no results of its use with modern generators are available, are greater than may be supposed. Thus it had been found that an electric arc lamp is of itself a telephone receiver. The big light that hangs from a pole on the street corner may be made to talk! From the carbons in a lighted arc lamp there arises a column of vapor. If the lighting current is varied by superimposing upon it a telephone current, the column of vapor around the carbons in the lamp will fluctuate and sound waves corresponding to the words spoken into the telephone will be given out. Music can also be sent through the arc lamp—the notes of a bugle coming clear and distinct from an ordinary electric light when no bugler is in sight afford a striking illustration of things already done.

The application of the instrument to maritime use has also been developed, and it would be possible for one ship captain in his cabin to hear another in his cabin, or to hear from the shoreline, by means of this, the original radio-telephone.

It can be used in the daytime as well as in the night time, but fog is its enemy.

It has been used by the German Government for lighthouse work, and by the U. S. Signal Corps.

It may yet be that the "talking arc," will come into its own, in spite of, or even in



conjunction with, the radio telegraph and the radio telephone.

And, at any rate, it will be just as well for Science, to add to its records of the original radio phone, which attracted scientific atten-

tion the world over long ago, those first words uttered on that eventful Sunday, February 15, 1880: "Mr. Bell, Mr. Bell, if you hear what I say come to the window and wave your hat!"

Increasing the Selection Power of a Radio Circuit

By JOHN V. L. HOGAN

Consulting Engineer, New York; Fellow and Past President, Institute of Radio Engineers;
Member, American Institute of Electrical Engineers

WE HAVE seen that by correctly coördinating the amount of capacitance and inductance in a freely vibrating radio circuit, we are able to secure an agreement between the most easily attained or natural vibration rate of the circuit and the received radio waves.* Each radio wave has a definite predominant frequency of vibration; the standard broadcasting wave oscillates at the rate of 833,000 cycles per second. By adjusting the capacitance of an intercepting or receiving aerial and the inductance of the tuning coil connected to it, we may make the natural oscillating frequency of the circuit from aerial wires to ground exactly the same as the frequency of the arriving wave; in this case there will be produced the greatest possible amount of current in the receiving aerial system, and consequently the loudest possible signals will be heard in an associated receiving telephone.

SOME LOGICAL CONCLUSIONS

A NATURAL conclusion to draw from the fact that agreement of natural and received wave frequencies results in maximum current is that disagreement between these frequencies would cause a reduced flow of current. That is, we would expect to hear weakened signals if we adjusted our antenna capacitance and tuning coil inductance to correspond to a circuit frequency differing from the received wave frequency. That is exactly what does happen when the experiment is tried.

But when we change the circuit frequency to a value different from the tuned or resonant value, at which it is in harmony with the received wave, how much will our signal strength be reduced? For example, how far must we de-tune the circuit (or how great must be the disagreement in frequency) before the current is reduced to one-half its maximum or resonant value? This is the question whose answer explains the matter of *sharpness of tuning* or the selective power of radio receiving instruments.

To understand why one resonant circuit will tune more sharply than another, we must consider a little more closely what happens while such a circuit is oscillating. As we have seen, when a charged condenser is connected into a circuit including an inductance coil, the electrical energy stored in the condenser will discharge as an electric current through the coil and circuit. The current does not die away and vanish unless the circuit is poorly conductive; it "overshoots" and recharges the condenser in the opposite direction. Immediately thereafter, the condenser discharges backward through the coil and circuit, the electrical momentum or overshooting action of the coil causing a third recharge of the condenser. This time, however, the direction of the charge is necessarily as it was when the current oscillations were started. It is not hard to see that such successive reversing discharges of the condenser will generate an alternating current in the system, and that the frequency of this alternating current will depend upon the size of the condenser and the coil. The larger the capacitance of the condenser (just as the greater the flimsiness of the spring in a mechanical

*"Tuning the Radio Aerial System" by John V. L. Hogan. RADIO BROADCAST, June, 1922, p. 107

vibrating system) the less will be the force tending to produce the electric oscillations, and consequently the slower their frequency will be. The greater the inductance of the coil (just as the larger the mass of the vibrating weight in a spring pendulum) the greater will be the electric inertia of the circuit, and consequently the lower will be the natural alternating current frequency.

REGARDING THE CONTINUITY OF OSCILLATIONS

HOW long will such a circuit continue to oscillate, once the electric vibration has been started? Will the condenser continue to discharge and recharge indefinitely, or will the electric energy originally stored all be used up after a certain number of oscillations have taken place? The fact is that each successive re-charge is a little less than the one preceding it, because some of the electric energy is lost in heating the wire of the coil and circuit during each oscillation. The amount of energy thus lost is proportional to the electrical *resistance* of the circuit, which is simply a measure of the opposition which exists to current flow in any conductor. Clearly, the greater the resistance of the oscillating circuit, the more energy will be lost at each swing, and consequently the fewer electric vibrations that can take place before the current dies away to an immeasurably small value.

Fig. 1 shows a simple oscillating circuit in which the resistance is small, being merely that of the wires and coil. In such a circuit the oscillations will continue for a comparatively large number of swings, and hence it is called a *persistent* oscillator. Fig. 2 represents a gradually reducing or persistent train of oscillations such as would exist in a persistently oscillating (or, as it is often called, feebly damped) circuit. On the other hand, we may increase the resistance of our circuit by inserting a resistor as in Fig. 3. This will make the circuit less persistent or more highly damped, and, since each condenser recharge will be considerably smaller than that which preceded it, the number of cycles of oscillation before the current dies away to a useless value will be much reduced. Fig. 4 indicates such a highly damped train of oscillations, the reduced number of vibrations resulting from an increase of the circuit resistance. If the resistance is made too large, the circuit will not develop any free electric oscillations whatever, for so much of the condenser energy will be used up in

the first discharge that no inertia or recharging effect will appear.

Now let us consider what this matter of cir-

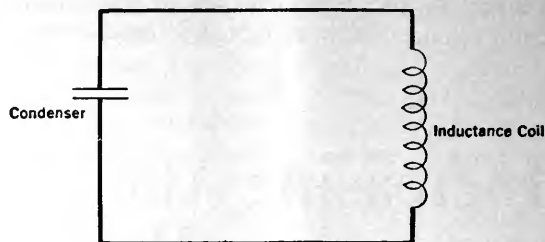

Fig. 1: A persistently oscillating simple resonant circuit

cuit persistence, or the varying number of free oscillations, has to do with sharpness of tuning. We have seen that as the natural frequency of a receiving antenna is varied, from a value

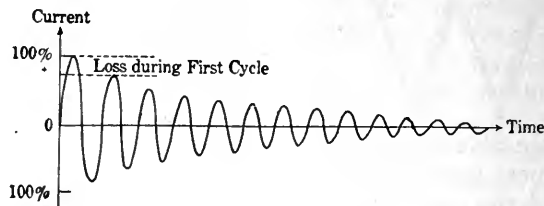

Fig. 2: A persistent train of oscillations such as would occur in the circuit of Fig. 1.

below the wave frequency of an arriving radio signal, upward to and then beyond that frequency, the current flowing in the antenna circuit increases to a maximum and then de-

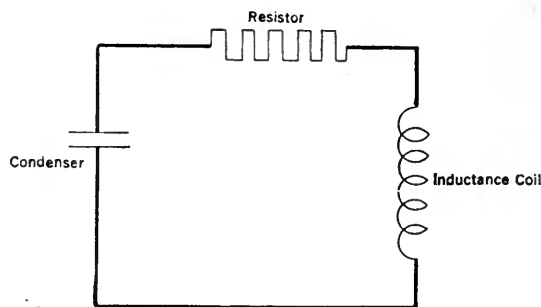

Fig. 3: A simple resonant circuit including a resistance unit which decreases its persistence

creases. The largest current value occurs at resonance, or when the frequencies are in agreement. The rapidity with which the current increases as the resonant point is approached is what determines the sharpness of tuning of the circuit.

The antenna-to-ground circuit of Fig. 5 behaves almost exactly as does the closed res-

onant circuit of Fig. 1. If the antenna itself were charged, like a condenser, by virtue of its capacitance, and allowed to discharge through the tuning coil to ground, it would vibrate

In other words, the higher the resistance effective in a tuned radio circuit, the less sharp its tuning will be. Since the selection power, by means of which the circuit discriminates be-

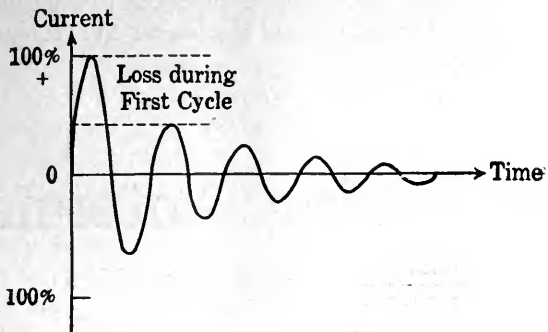

Fig. 4: A more highly damped oscillation train, characteristic of the non-persistent circuit of Fig. 3.

electrically at its natural frequency. The number of oscillation cycles before the current died away to negligible values would, as before, depend on the effective resistance of the circuit. Thus, if the switch were opened so as to put into the circuit the resistor shown in Fig. 5, the number of oscillations would be reduced just as in the case of the closed circuit.

If, now, we adjust the aerial circuit (by changing the inductance of the tuning coil) so that its resonant or natural frequency is 833,000 cycles per second, we will secure maximum antenna current from any station sending at that frequency. If the sending plant's wave is altered to a value above or below 833,000 cycles, the current in the receiving antenna will be reduced. We may plot, as in fig. 6, the amount of current which will be set up in the antenna as a sending station is adjusted to transmit successively all wave frequencies from 800,000 cycles to 875,000 cycles, both with and without the resistor in series.

The amount of resonant maximum current which will build up in any such circuit depends upon the degree with which the free or natural oscillations in that circuit cooperate with the arriving impulses to magnify their effects. Thus, the more persistent the natural oscillations are in the antenna, the greater and the sharper will be the rise of current as the resonant frequency is approached and reached. This is quite clearly shown by the curves of Fig. 6; when the resistance of the circuit is increased and consequently the persistence of its natural oscillations reduced, the resonant rise of current is neither so sharp nor so great.

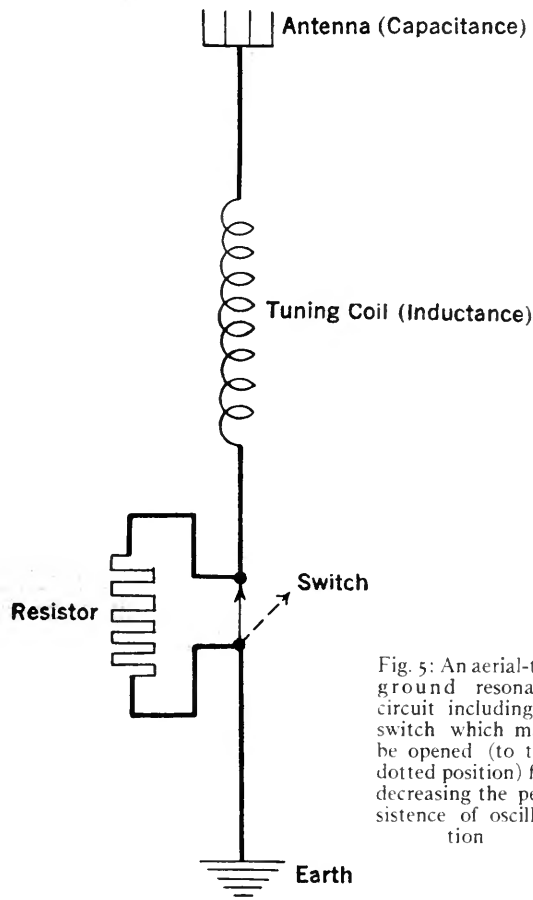

Fig. 5: An aerial-to-ground resonant circuit including a switch which may be opened (to the dotted position) for decreasing the persistence of oscillation

tween waves of different frequencies for the purpose of avoiding interference, depends directly upon the sharpness of tuning, it is obvi-

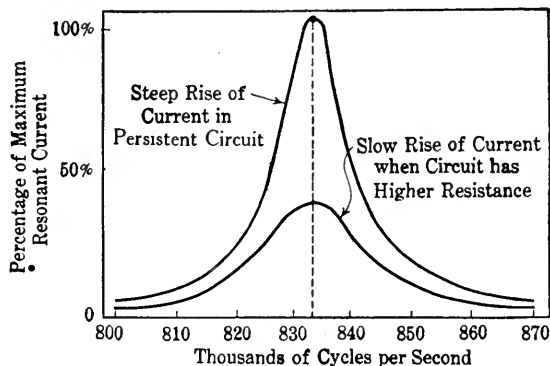

Fig. 6. Curves showing how the addition of resistance to the antenna circuit reduces the sharpness of tuning

ous that for best selectivity we must keep the wasteful resistances in our tuned radio circuits as small as possible.

The problem of building radio receivers which tune sharply and operate efficiently thus reduces itself to the provision of a way to abstract radio-frequency power from a tuned cir-

cuit, such as an antenna system, without unduly increasing its effective resistance. In general, the less opposition to current flow in the receiving circuits the greater will be their persistence, the sharper their selective adjustment to frequency, and the louder the received signals.

Protection of the Receiving Antenna

Many Radio Enthusiasts Have Been Worried About Their Antenna as a Lightning Hazard. The Following Description of Lightning Protection Includes the Much Desired Information Which Should Relieve This Apprehension. It Includes the Latest Recommendations of the National Board of Fire Underwriters

By G. Y. ALLEN

AS READERS of the June issue of "Radio Broadcast" will remember, Jim Black's initial radio set consisted of a small crystal receiver using a bed spring as an antenna. As was to be expected, however, Jim shortly outgrew such elementary equipment with its limited range, and experienced a desire to listen to stations farther away than was possible with a crystal detector. So one evening last week he carried home a small tube regenerative outfit.

In order to increase the possibilities of hearing distant stations, he erected a single wire antenna on the roof of the apartment house in which he lived. He hoped to hear Springfield and possibly Pittsburgh on this outdoor antenna.

He had given no immediate thought to the protection of his antenna until Mrs. Black raised the question one evening during an early summer thunder shower. No damage was done that evening, but the possibility of his antenna being a fire hazard worried Jim and he resolved to interview the dealer from whom he had purchased his set and find out what must be done to safeguard the apartment from damage.

Accordingly, the following noon found Jim at Gardiner's electrical store.

"Well, Mr. Black, how does the set work?" asked Mr. Gardiner.

"Slick as a whistle," said Jim. "We heard Detroit night before last, and Schenectady

comes in so loud that we can hear him in the next room."

"Fine work," said Mr. Gardiner. "You must have made a pretty good job of putting up that antenna. By the way, you didn't get a lightning ground switch when you were here last week. Thunder storms will be coming pretty frequently now and you'd better be prepared."

"That's just what I wanted to ask you about," Jim acknowledged. "The wife was a little scared last night during that shower, and I want to know what I must do to make the installation absolutely safe."

"That's easy," said Mr. Gardiner. "Just attach one of these hundred ampere double throw single pole switches outside of your house and run a number four copper wire down to a piece of pipe driven into the ground."

"Do you mean to say that I have to attach that thing to the outside of the house and run a piece of that heavy wire down the front of the building?"

"That is what the rules specify," said Mr. Gardiner.

"Well, I have a fine chance of getting away with that in our neighborhood," said Jim. "Guess that little old antenna comes down if that's the way it has to be protected."

Jim left the store in a very depressed state of mind. He did not want to remove the antenna because Mrs. Black took so much pleasure in listening to the concerts, and furthermore, he liked to fuss around with the set

himself. Yet he knew that it was an impossibility to disfigure the apartment house with a heavy switch and wire. It did not seem right to require a fifty-foot span only a few feet above the roof of the apartment to be protected by such a large switch when telephone wires of much greater length were protected only by a small fuse and protector attached to the window sill in the basement.

While thinking the matter over, Jim happened to remember an old friend who had recently become a fire insurance inspector and he decided to talk to him before removing the antenna from the roof.

The following day Jim called up his friend and went out to lunch with him. After the orders had been given Jim started immediately to question him on the protection of antennas. He told how he had installed the set without giving much thought to protection of any kind and of the information given him by Mr. Gardiner.

"Now, Bill, you know there isn't one chance in a thousand of my being able to put a heavy switch outside of the house, and as for running a heavy copper wire down the side of the house, that is certainly out of the question."

Bill looked at Jim's troubled face and smiled.

"Your friend Gardiner is surely a back number," he said. "The Fire Underwriters have recently revised the rules applying to the protection of receiving antennas and when the new simple specifications are followed, the antenna is a protection to the building on which it is erected instead of being a hazard.

"Instead of a heavy switch mounted outside of a building, which by the way you may forget to throw, you use a small gap permanently connected to a grounded wire. The gap is adjusted to operate at a voltage of five hundred or less. The protective device may be placed inside of the building and instead of a heavy and unsightly copper wire, you will need only a number fourteen wire connected to the nearest grounded water pipe or radiator."

As Bill talked he drew a sketch on the tablecloth similar to that shown in Fig. 1.

"Well, now you are talking," said Jim. "Where can I get one of these gaps?"

"You ought to be able to get one at any up-to-date dealer's," replied Bill.

And so, the lunch being over, Jim arose in a much better frame of mind than when he sat down, and immediately purchased a protec-

tive device which he took home and installed that night.

The latest revision of the Fire Underwriters code applying to receiving antennas has made possible the approval by fire insurance inspectors of installations that could not possibly be made acceptable under the old rulings. Manufacturers have been quick to recognize the value of the new requirements and there are now several protective devices on the market which meet these requirements.

The available types are divided into two classes, namely, the enclosed atmospheric type and the type in which the discharge takes place either in a vacuum or in some rare gas. This latter type is always sealed into a glass bulb.

Fig. 2 illustrates one of the vacuum type

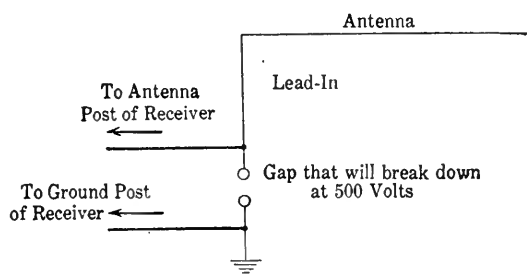

Fig. 1. Illustrating in a very simple manner the scheme for protection from lightning. When an electrical charge strikes the antenna, it jumps across the small gap and is carried to earth

protectors and figure 3 shows its construction. The distance between the spheres between which the discharge takes place is not critical and the adjustment for the proper voltage may be controlled by the quality of the vacuum.

Fig. 4 illustrates an enclosed atmospheric type of protector. It is similar to the lightning arrestors used for telephony with the exception that the blocks used are of special design. Telephone protection generally requires a permanent ground after the initial breakdown of the gap whereas this property is highly undesirable in radio protection. In fact, static, which is of frequent occurrence during warm weather, may discharge across the protector gap to ground many times a day and a satisfactory protector must be capable of withstanding such service.

Fig. 5 illustrates the construction of a gap of this kind. As can be seen, the gap consists of carbon blocks made of a special grade of carbon separated by a porcelain block. The quality of the carbon is such as to minimize the formation of carbon dust thus remov-

ing the possibility of short circuiting the gap. The protector has the further feature of permitting easy replacement of the carbon blocks should this be desirable.

The latest revision of the Underwriters code specifically rules against the exposure of a radio

precaution the user of such a protector should take is to be careful not to come in contact with the antenna wire on the outside end of the fuse without having it first thoroughly inspected by a representative of the power company.

The construction of the protector is illustrated in Fig. 7. It will be noted that the gap is formed by two punched brass pieces separated by a mica washer approximately two thousandths of an inch thick. This gives a gap that will break down at approximately five hundred volts and which will stand repeated static discharges. The porcelain base provides excellent insulation.

The new regulations permit installation of the protector within the house, and allow the use of number fourteen B. & S. gauge wire or its equivalent for connecting the ground terminal of the protector to a grounded structure. A single throw single pole switch of small capacity may be used in addition to the pro-

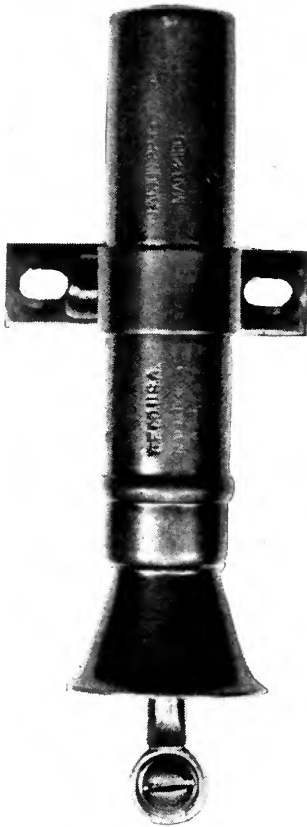

Fig. 2. One of the latest types of vacuum-gap lightning arresters is illustrated here. Its internal construction is shown in the accompanying sketch

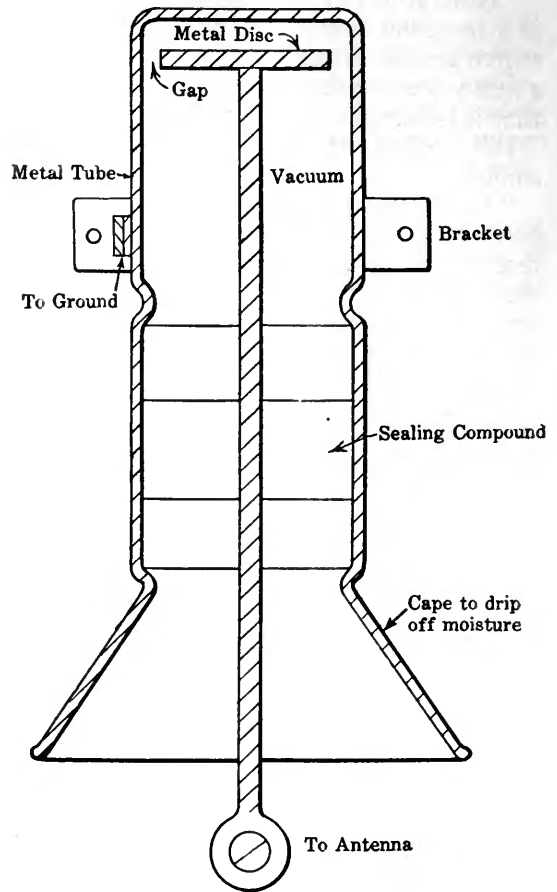

Fig. 3. The internal construction of the protective device shown above

receiving antenna to electric wires carrying voltages of six hundred or more. It can easily be appreciated, however, that installations initially free from such exposure may later become hazardous through no fault of the owner of the radio set. To protect the user fully under such conditions one of the manufacturers has designed the protector shown in Fig. 6. This protector is provided with a two-ampere fuse, and, should the antenna inadvertently become crossed with a power wire, the current to ground through the fuse will cause it to blow, protecting the radio apparatus and isolating the antenna. This makes all apparatus on the receiving side of the protector safe. The only

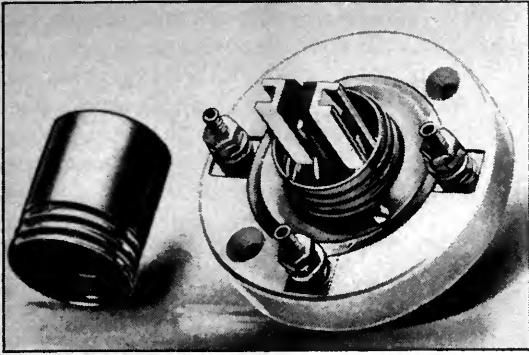

Fig. 4. Another type of protective device. The gap element may be replaced if necessary

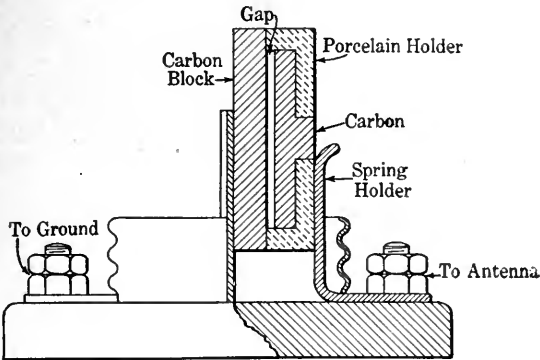

Fig. 5. The construction of the protective device shown above

protective gap if desired. This is shown in figure 8 on the next page.

The ground wire leading from the protector should be supported on porcelain knob insulators and may be connected to a water pipe or to a hot water or steam heating system that is electrically connected to ground. The pipe should first be carefully scraped or cleaned with sandpaper and an approved ground clamp placed around it. Installations in steel buildings may use the building frame as a ground.

If the installation is made in the suburbs where there is no city water supply, a piece of pipe seven or eight feet long may be driven into moist earth and the ground clamp attached to this.

ANTENNAS NEEDING NO PROTECTION

THE new regulations specify certain types of antennas which are exempt from any protection requirements whatsoever. Among these are the indoor antenna and the loop antenna.

For covering moderate distances a very

efficient antenna can frequently be erected wholly within the house. In individual houses, three or four wires supported on the rafters in the attic make a very desirable antenna, particularly in frame houses. In apartment houses good results can frequently be obtained by running one to four wires the length of the apartment just below the ceiling. If such a diminutive antenna produces sufficient signal



Fig. 6. A popular type of lightning arrester fitted with a fuse to protect the antenna in the event of its coming in contact with high voltage power lines

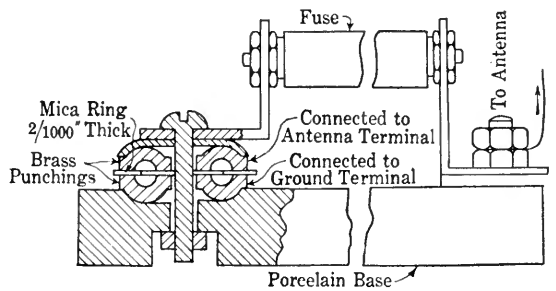

Fig. 7. The internal arrangement of the protector shown above

strength it has the advantage of reducing to a large degree undesirable noises such as static,

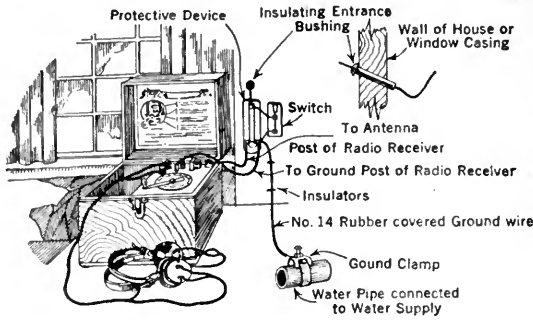

Fig. 8. The method for employing the lightning protective device installed within the building and connected to a suitable ground

and also cuts out a large amount of interference from spark telegraph stations.

The loop antenna is another type that requires no protection. The loop, however, does not collect as much energy as does the indoor antenna and so will not cover as great distances without the use of more sensitive receiving apparatus than that generally used. But the loop antenna has many desirable qualifications and gives promise of development in the future.

In general, the latest revision of the Fire Underwriters rules will make the advantages of broadcasting receivers available in many cases in which installations would have been impossible under the old regulations.

A Church With a Mighty Congregation

Pastor M. E. Dodd of the First Baptist Church, Shreveport, La., Who Installed a Radio Broadcasting Station so that His Aged Mother Four Hundred Miles Away Could Hear Him Preach, is Reaching Thousands of Radio Enthusiasts

By ARCHIE RICHARDSON

WHEN the first radio services were held one Sunday in May in the new half million dollar building of the First Baptist Church of Shreveport, Louisiana, but a small portion of the worshippers were found in the church auditorium.

The rest of the congregation were scattered throughout the United States, in portions of Mexico and upper South America, on the islands of the Gulf of Mexico and in ships at sea.

One of the country's most powerful radio broadcasting stations carried the pastor's voice through the hundreds of miles that lay between him and his hearers.

In hundreds of churches served by circuit riders, in hospital wards, in orphanages and old people's homes and in residences of those affiliated with this church, receiving sets are being installed to take advantage of the opportunities offered by the first powerful radio broadcasting station in this part of the country.

A 200 watt set, using a powerful motor

generator and operated by a licensed commercial operator, was used. The station sends out on a 360 meter wave length. The call number has not yet been assigned.

The station is located in the 10-story tower of the church. The antennas are suspended between the top of the tower and a 30 foot skeleton steel tower built on an office building across the street. They consist of four copper wires, 125 feet in length, 100 feet above the ground.

It was planned to broadcast the dedicatory services on Sunday, April 22, but part of the equipment failed to arrive in time to be installed before these services.

The normal radius of the station is 300 miles, but under favorable conditions it can be picked up from coast to coast, and is audible in portions of South America.

The broadcasting feature of the new church plans was arranged primarily in order that the aged and invalid mother of the pastor might hear the sermons of her son. At her home in Trenton, Tenn., nearly 400 miles away, a

receiving set has been installed in her bedroom, and daily it will bring to her the voice of her son.

Mrs. Lucy Williams Dodd, the mother of the pastor, Dr. M. E. Dodd, is nearly eighty years old, and for the last two years has grieved because she could not hear his sermons.

in late years has caused her to lose touch with many of the world's developments. But her son reminded her that when telephones first came into general use, she had said she would have none of them in her home.

She consented to a trial, and a radio set was installed in her home. Now she is an enthusias-



The pastor's mother, Mrs. Lucy Williams Dodd, eighty years old and an invalid, listening by radiophone at her home in Trenton, Tenn., to her son in Shreveport, La. The broadcasting station was installed in the church primarily so that she could hear her son's sermons

While Doctor Dodd was visiting her recently, she expressed the fear that she would never hear him preach again. That was the suggestion that led to the installation of the broadcasting station. He made her a promise that arrangements would be made so that she would hear every service he conducted as plainly as if she were sitting in a pew before him.

For a long time Mrs. Dodd was skeptical. The retired life her illness has forced her to lead

tic radio fan. Daily she listens to concerts and lectures sent out from broadcasting stations, and enthusiastically declares that the new-fangled ideas aren't so bad after all, especially for a woman of eighty who can scarcely leave her bed. And now the completion of the station in the Shreveport church has enabled her to listen to the voice of her own son.

Hundreds of churches that have no pastor or that are able to have a preacher only once or



First Baptist Church, Shreveport, La.

twice a month have installed or are planning to install receiving sets. Now that this church station has been completed, they will have services twice every Sunday and throughout the week as regularly as the city church. And they will have the same sermons and the same music that the people of the biggest Baptist church in the world enjoy.

It is stated that half of the Baptist churches of Louisiana are without pastors. The same is true of many other states. These churches are in small towns and in neighborhood settlements, in many cases off the railroads. Bad roads make many of them inaccessible through a large portion of the year.

That the church radio will be a boon to the isolated congregation is agreed by all religious workers. Many preachers declare that radio offers the church bigger opportunities than anything science has produced since the invention of the printing press. Some say that it ranks above the printing press in importance.

The rural church, long a neighborhood gathering place, will take on greater importance as a civic, educational and cultural centre, as a result of the installation of radio. People will gather at the church evenings throughout the week, as well as on Sunday, to hear the best

in music and lectures, to receive market reports, to get the day's news, and to hear the many other things offered by the country's broadcasting stations.

But radio will not take the place of the pastor of the small church, according to almost unanimous verdict of church leaders. They say the personal touch of the individual minister cannot be supplanted by the radio service. They regard it as supplementing his work, and offering him opportunities for bigger work, rather than substituting for him. Many a church has fallen apart through lack of a pastor, because there was no reason for the congregation to assemble. The radio is expected to remove this condition of affairs.

Aside from the religious services, many features will be broadcasted by the Shreveport church station. The auditorium, the largest in the city, has been offered as a civic and educational centre. The world's greatest singers and lecturers will be heard here, and their concerts and lectures will be available to all who have receiving sets. On the ninth floor of the church tower is a 13-bell chime, of which the largest bell weighs 3,000 pounds. Daily concerts are given by a trained chimer. A chime connection makes the broadcasting of

these concerts a simple matter. Recitals on the four-manual organ of the church, together with choir and congregational singing, will be features of the programme. A daily news service is being arranged for.

The pastor states that the performance of marriage ceremonies will be one of the tasks of his radio station. A marriage performed by radio is just as legal, and the ceremony can be as impressive as if the minister were present in person, he says. This, it is pointed out, will permit a couple to have their wedding solemnized by the minister of their choice who may be hundreds of miles away. The only thing in the way of a ceremony of this kind seen by Doctor Dodd is the tendency of the bridal couple to arrive late, but he thinks a way can be found to get around this.

The pastor expects to reach many of his flock who are addicted to Sunday morning automobile trips through his radio outfit. He will insist that when they go out Sunday morning they carry receiving sets in their cars.

There is only one fly in the ointment for the pastor. He is much concerned over the fact that a bed spring makes a splendid aerial. Much of his work, he says, is to get members of his flock out of bed in time for Sunday school or even the morning preaching service. When the people learn that they can listen to the services by attaching the receiving set to their bed springs, he fears there will be a growing tendency to lie abed Sunday mornings.

The matter of collections isn't worrying him, he says. While it is impossible to pass the collection plate around with his congregation scattered over forty-eight states, he says that just as effective means will be devised for financing the activities of the church.

The broadcasting station is but one of the unusual features found in this church, which is declared to be one of the most remarkable church plants in the world.

A 10-story tower, which furnishes quarters for a Sunday School of 3,000 and many young people's societies, has attracted much attention.

The upper portion of the 10-story tower of the First Baptist Church of Shreveport, La., is shown in the foreground; the dome over the main auditorium in the background, and the roof garden to the right of the tower

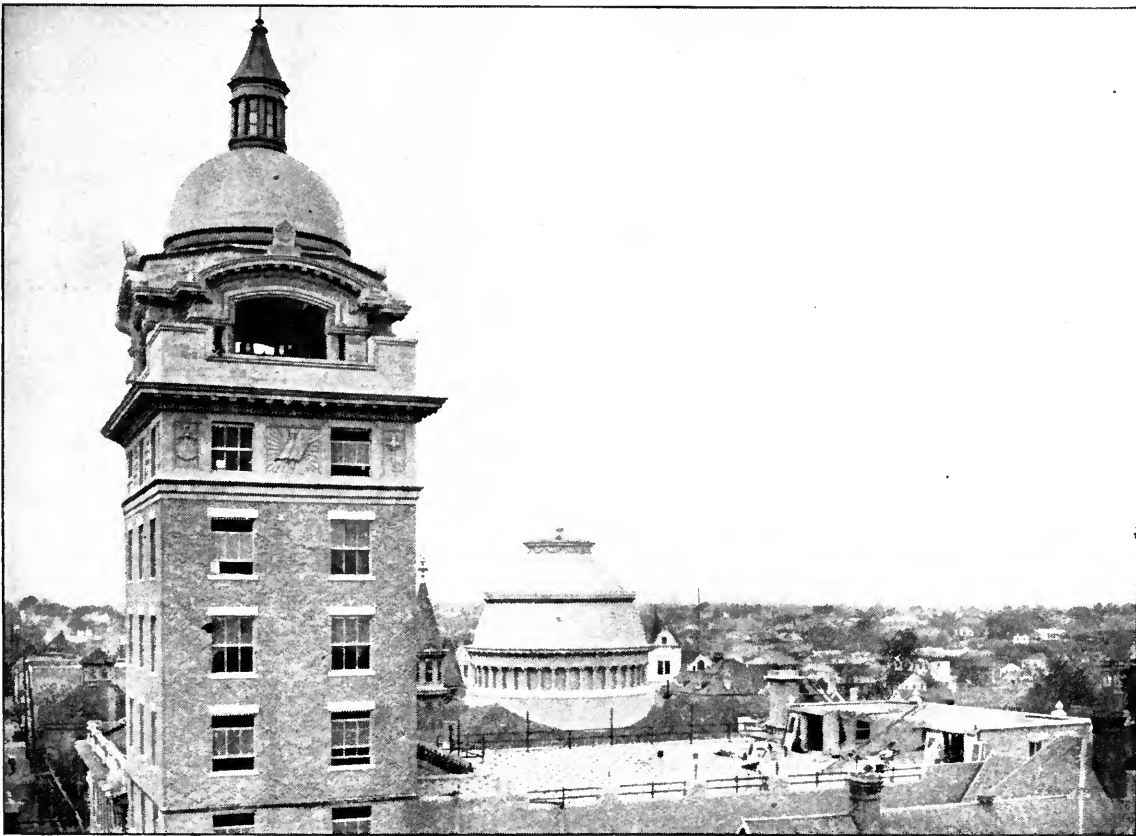

The four floors of the main building, together with the tower, have a total floor space of 51,500 square feet, and a combined seating capacity of 8,000 people.

The main auditorium will seat 3,000 people. It is equipped with a four-manual organ, and

toys, sand piles, and children's furniture, under the supervision of a nurse, cares for children of mothers attending services or working or shopping down town during the week.

The dining rooms furnish noon lunches daily to several hundred girls and women employed

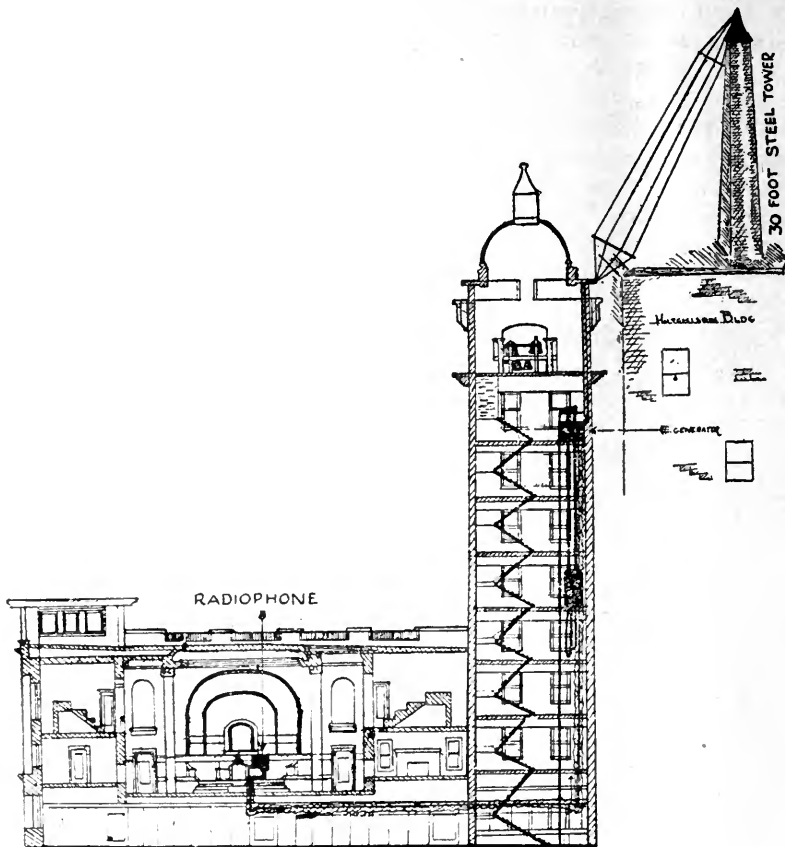

Drawing showing details of the radio installation

a chime connection. The transmitter of the broadcasting outfit is inconspicuously located in the pulpit, and connected with the generator by wires that run under the floor and up the elevator shaft.

Even the deaf will be provided for in this auditorium. An acousticon outfit has been installed with a transmitter in the pulpit, connecting by concealed wires with the pews. The roof garden provides accommodation for 1,000 people. During the summer, outdoor services, concerts, and socials will be held here. The nursery in the basement, fitted up with

downtown. Several banquets are served every week.

The banquet hall seats 500 people at two long tables.

A gymnasium is located in an upper room of the tower.

The congregation of this church numbers 2,200. Ten years ago its membership was 500. While the city has shown a growth of 43 per cent. the membership of the church has increased 400 per cent., while the contributions of the church to all causes has increased 3,000 per cent.

Random Observations on Running a Broadcasting Station

Success Demands a New Type of Impresario Who is a Sort of Combination Editor and Theatrical Manager

By H. M. TAYLOR

RUNNING a broadcasting station is a novel, not to say fascinating experience. There is no precedent to follow. There is no literature on the subject (that is, no literature in the usual sense; I do not refer to letters from the radio audience advising how the broadcasting station should be run). Each broadcaster, generally speaking, has to work out his own code of rules, use his own common sense, make his own formulæ, and profit by his own mistakes. Without doubt a broadcasting technique will soon be worked out. It is being done now—rapidly. But in the present state of the radio art, this technique is incomplete—embryonic.

There are two major problems to be encountered by those running a broadcasting station. One is the mechanical or technical side. The other, for want of a more descriptive characterization, may be termed the human side. Both are of the utmost importance. The public, which is the ultimate judge of the success of a broadcasting station, can never be satisfied if one side is defective. Good programmes count

for nothing if the technical mechanism does not put them out so that the average person can receive them clearly and fairly easily. And perfect reproduction and transmission of programmes avails little if the operator in charge does not possess a pleasing voice, speak correctly, put on his numbers without long waits and possess a certain indescribable mental agility of his own.

Then the artists who entertain play an important part, of course, in the success or failure of the broadcast. To find an operator who understands human nature so that he can be sympathetic and at the same time manage temperamental artists, successful business men and others who have attained prominence in world affairs, who can surmount the internal friction

ever present in all organizations, and who, in addition, thoroughly comprehends the scientific and mechanical operation of the broadcasting equipment, is difficult, to say the least. As the old farmer at the circus said, "There ain't no such animile."

Almost every large broadcasting station is operated by several men, with one man respons-



Miss Eunice L. Randall telling a bedtime story in WGI, Medford Hillside, Mass.

ible for its success. No one individual, at present at least, possesses all the qualifications necessary for running a broadcasting station. My own idea of the organization of a broadcasting department is to put a trained advertising man at its head and surround him with technical operators possessing as many of the so-called human virtues as possible. Tact, sincerity and unfailing good-nature are just as valuable as the possession of a first-class commercial license. A ready use of proper phonetics is as essential as a knowledge of atmospherics. The rise of radio broadcasting, besides opening up limitless commercial possibilities, and attendant problems, besides furnishing a new source of entertainment and inspiration to the general public, has produced a new type of impresario exemplified by him who runs the broadcasting station, and a new kind of vocation for a corps of assistants as well.

It is not my intention in this article to air my own personal views and activities in running a broadcasting station. I do not wish to pose as an expert, because I don't believe the expert has arrived. But I do believe the thousands and thousands of people "listening in" to radio programmes every night might be interested in the many difficulties, human as well as technical, which are encountered at the transmitting end. Moreover, an exchange of ideas among those struggling to put over programmes for the public interest, may help to improve those programmes for that same public.

I will never forget my first experience in putting out a high-class programme. It was in the early days of radio broadcasting. The main feature was a piano recital by a prominent concert artist. The possible audience was estimated at 25,000, an audience now tripled, and then some, for any large broadcasting station. I was to introduce the artist and had prepared a speech in carefully chosen words. Nonchalantly, I picked up the microphone to make the announcement on the evening which was quite an event for us in the annals of broadcasting. With perfect sangfroid I removed a cigar and started to open my mouth. All of a sudden, in such a rush, I saw before me 25,000 people, *strangers*—before *me* to whom a speech before a score of *friends* was enough to start the cold sweat and the knocking knees. Who was I to talk to such a vast assemblage!—such a throng as witnesses inaugurations, baseball games, and bull fights! For a moment I had radio stage fright in its

most acute form—but only for a moment. The attack passed as quickly as it had come. For I realized no one could see me, except the artist and my everyday associates.

To many, perhaps, this attack of radio stage fright may seem a bit incomprehensible. Yet, artists who entertain large concert audiences tell me they experience similar emotions, although very likely in much lesser degree. It is uncanny to sing one's best to a hundred thousand people—all unseen. Some artists unfamiliar with the extent that radio broadcasting has swept the country, frankly appear sceptical. Hardheaded business men often show by their expressions a certain doubt that their messages were actually heard by thousands. They have been *told* there is a large listening audience scattered over many states, but seeing is believing—except in radio. It is because of this uncertain feeling, this natural lack of complete faith on the part of the uninitiated, that broadcasting stations are continually asking those hearing their programmes to write in and let them know it. One of the most helpful ways in which an individual can assist the broadcasting station, now maintained at large expense to the operating company and giving programmes entirely free of charge, is to drop a card acknowledging receipt of the broadcast.

Constructive criticism from those hearing the broadcasting is of course always welcome to all stations. Even destructive criticism may be helpful. As for anonymous, destructive criticism, perhaps the least said the better. I suppose every broadcasting station occasionally receives anonymous communications, just as does every newspaper or magazine editor and man in public life. As long as there is darkness, there will no doubt be people who prefer to cloak their movements in deepest shadow.

The letters received in answer to requests for them, as well as unsolicited letters (of which there is a great number, showing that the spirit of the American public is right, as has always been maintained by those long in contact with it) run the gamut of personal opinion. Some would have all jazz music, others nothing but grand opera. Some like educational lectures and talks, others would have only music. Subdividing, some would have violin reproduction predominant, others would eliminate it entirely. (Any type of instrument may be substituted for "violin" in the above sentence.)

There are those who are "bored to death" with talks of interest to women, or market and stock reports, or code practice and instruction, or bedtime stories, or popular music or "highbrow" stuff. And then there are those who like these things, or some of them. Just as among a group of ten thousand newspaper readers there are comparatively few who read with equal interest the same page or article, so tastes vary in radio broadcasting programmes. The programmes are arranged to meet these divergent tastes as far as possible. Experience seems to indicate just now that musical features should predominate to a greater or lesser extent. The musical programme should be as varied as possible, giving the best, be it classical or popular in its nature.

I believe the tendency in the radio programme should be toward the classical, as people of taste and education, who can afford to own modern receiving apparatus, prefer this type of music. The balance of the programme may be filled with varied lectures, addresses by prominent men, readings, comedy sketches, and useful information. In all this, emphasis is put on variety. If broadcasting is to continue in popular esteem after the first novelty has worn off, then it is necessary, I believe, for the programme to be instructive and educational as well as interesting and entertaining. The man responsible for broadcasting programmes must have a rare sense of proportion, and be a fine judge of values. He must be a sort of combination editor and theatrical manager.

The first radio recital from WGI, Medford Hillside, Mass., was played by Miss Dai Buell. The concert was transmitted from an office temporarily made into a studio. The walls were hung with blankets and then covered with wrapping paper. The sound was caught by the large megaphone which at the time of the concert was at the extreme end of the sounding board of the piano. Although the broadcasting was rather crudely arranged, this music was heard in Ohio and Maryland, and other places between 500 and 1,000 miles



Almost as wide in variety as the suggestions about programmes are the requests regarding operating hours. A woman writes that her husband is a night watchman and does not wake up until 5 o'clock in the afternoon. He has a half hour to listen in at that time and two hours when he comes home in the morning between 8 and 10 o'clock. Couldn't we broadcast then? Dealers and merchants want broadcasting between 12 and one o'clock so that people can listen in on their noon hour, (a good idea). A young man wanted broadcasting after 11 P. M. because he didn't get home until that hour, as he attended night school three nights a week and worked evenings the rest of the time. The idea that still persists among some people concerning radio broadcasting is curious to say the least. The other night I was listening to one of our programmes in the reception room of the factory which is located a short distance from the broadcasting station. The night watchman came in wreathed in smiles and told me the following:

"A young lady just called me up," he said, "and said she would like to hear the radio. She said she did not hear anything. I asked her what kind of a set she was using and she replied—'I am just in a pay-station over in Boston. They told me to put a nickel in the slot and call you on the telephone and I would hear radio.'"

A woman who signed her name and address wrote in and said—"We enjoy your performance very much each evening and always have six or seven people listening. To keep husbands home at night 'Get a Radio,' says I. Be it said, friend husband even comes home in the middle of the afternoon now to hear your broadcasting."

Sometimes people make really alarming requests and are greatly incensed when we are unable to comply. A woman in New England wrote in recently that she wanted us to broadcast some dance music on Friday. "It must be next Friday," she said, "because I have got to be out both Wednesday and Thursday evenings." As my secretary says, "You'd almost think they were paying for it." Once

in awhile, after an unusually hectic day, I wonder if the radio public doesn't think companies who operate broadcasting stations are public philanthropists. A public servant is not a public philanthropist.

Another thing. There is a great difference in the report of a broadcast. A man in one town will say he "got the concert clearly and distinctly," while another man in the same town complains of a "hum," "a fuzzy rattle," or a noise "like unloading a tip-cart of bricks." Of course, reports regarding the concert itself vary with the taste of the individual.

I have been asked about the future of radio broadcasting. I am too busy with present details to have time to think much about its future. Then no one dares prophesy for fear of being reputed to-day a visionary and to-morrow exceedingly short-sighted. However, one thing, in my opinion, is certain besides "death and taxes," and that is some new method must be devised for financing radio broadcasting. Obviously, it is an enormous expense to the operating companies for which they are compensated by the sale of receiving equipment. But other companies can sell receiving equipment which will receive broadcasting programmes as well as those operating broadcasting stations. Far be it from me to mean by this statement that the sale of radio equipment should be limited to those at present operating broadcasting stations, but on the other hand the extra broadcasting expense, which benefits everyone in the business, cannot in fairness to all be borne by a few. Why can't there be a national broadcasting association, under government supervision, to the support of which every manufacturer of radio receiving equipment of a certain capitalization contributes? This is one suggestion. Another is that the government conduct and control broadcasting as it does the mails, or as cities do the water supply. These are merely suggestions and of course only a few of many possible ones. That radio broadcasting in some form will continue and improve and become more widespread is, to those close to this new, epochal industry, as certain as sunrise.

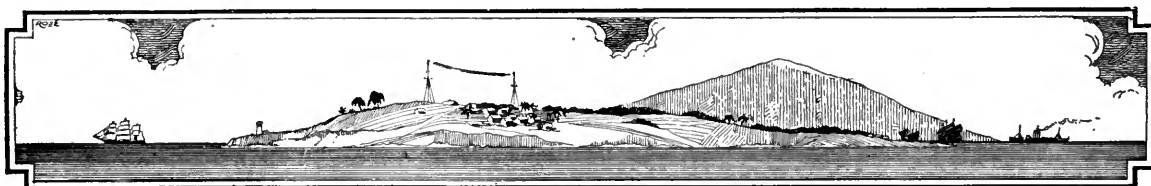

Radio Personalities

IV

REGINALD AUBREY FESSENDEN

By LUCILLE JOYCE

ALTHOUGH radio is but a side issue in the career of Reginald Aubrey Fessenden, inventor of the wireless telephone and radio compass, the smoke cloud for tanks, the electrically driven battleship, and the method of locating enemy guns by sound, and, as en-

six inches in outside diameter, giving a quarter horse power at 50,000 cycles and capable of being used as an amplifier with a ratio of 1-30 in current and 1-900 in energy of amplification; and a new type of radio telegraph receiver capable of recording each individual radio wave, thereby eliminating the troublesome static.

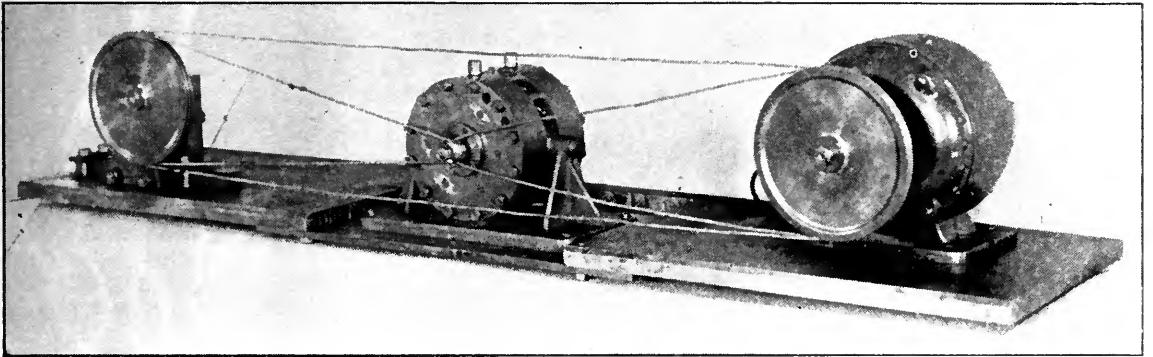

Professor Fessenden's radio frequency dynamo. The dynamo is in the centre and the machines each side of it are merely employed to drive it. Although it is but six inches in outside diameter, it is capable of delivering $\frac{1}{4}$ H. P. at 50,000 cycles. This machine is a forerunner of the present day high frequency alternators

gineering commissioner for the Ontario Power Commission, responsible for the mammoth power distribution from Niagara Falls, he has contributed to that science more perhaps than any other one man since the invention of wireless telegraphy.

Among his newest inventions which will soon be available to the average radio enthusiast, are a high frequency dynamo (Photograph D.), only

Photograph A shows such a receiver, and photograph B shows a record of dots made at a frequency of 50,000 cycles per second.

This photograph B is enlarged 2,000 times from the original record of the message, which is micro-photographed on a strip of photo film, moving 2 inches per second developed continuously, or on an 8 in. by 10 in. plate developed hourly. Each plate holds one hour's

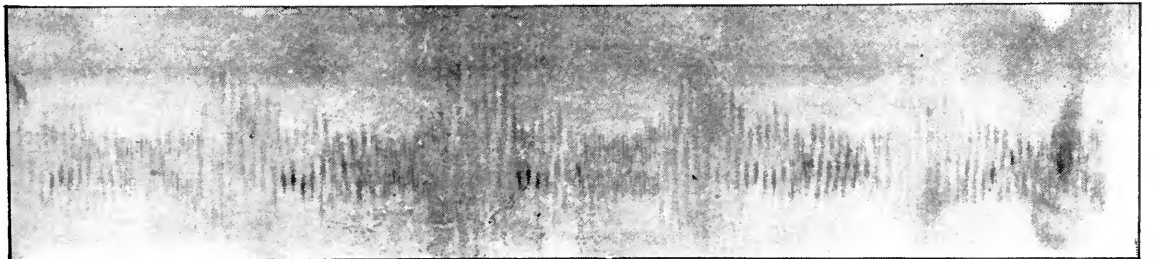

B. Record of dots made at a frequency of 50,000 cycles per second received by Professor Fessenden's new type of radio telegraph receiver

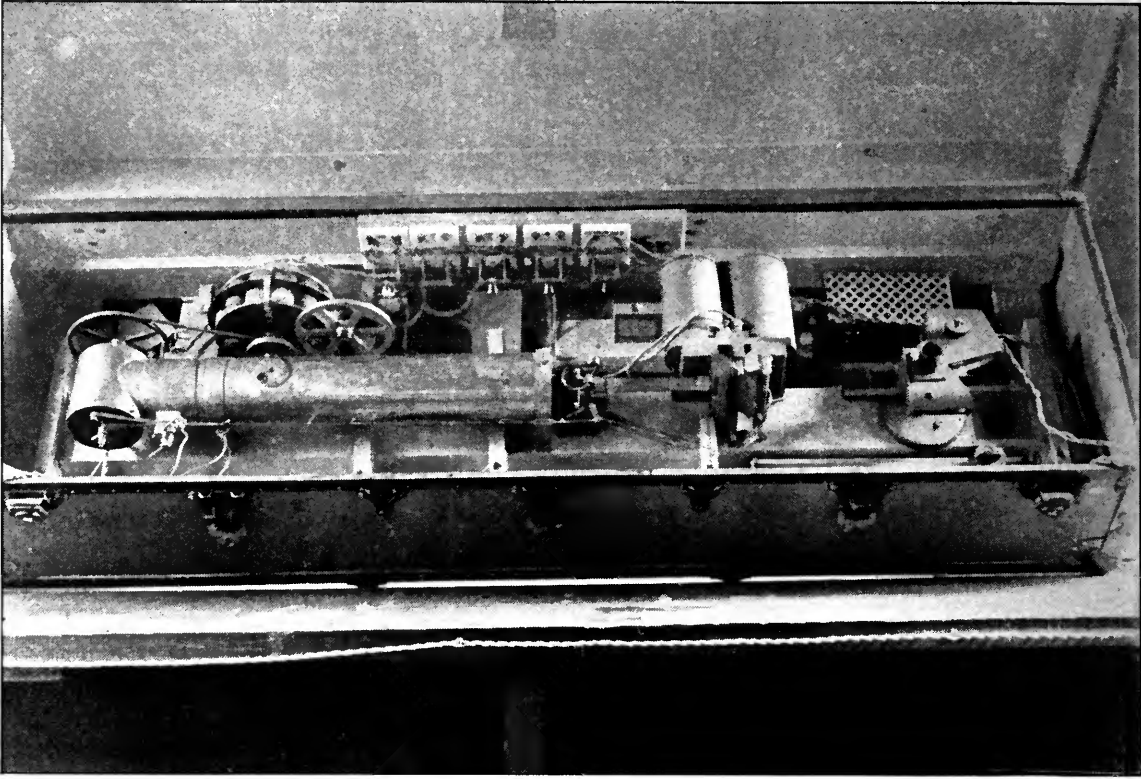

A. Professor Fessenden's new type of wireless receiver capable of recording each wireless wave, and used also in his radio camera

record of messages which may be transmitted at 500 words per minute or more. The film is used for periods of heavy static, and the plate for reference of the day's work. Two records are made simultaneously, one of the dots and dashes, and the other of the spaces, and with a highly damped aerial this gives reliable results.

A still more interesting development which Professor Fessenden already has in working order, and which will be demonstrated in the near future, is the transmission of moving pictures of scenes in distant cities. With the apparatus as he has developed it, it will be possible to point a radio camera, connected to a radio loop, at the steps of the Capitol in Washington, and by so doing enable every radio subscriber actually to see the President deliver his inaugural address and note every slight gesture he makes, as well as to hear his words by means of the radio telephone. Photograph A shows the receiving end of this radio camera.

The size of the picture, slightly limited at present, as it is received, is four feet by four feet on a screen twelve feet away, or four inches

by four inches on a screen twelve inches away. The coarse-graininess of the image at a distance of twelve inches corresponds to the 50 dot per inch process plate photo.

A method of overcoming cross talk, though of infinite importance in the transmission of speech, could not be published at the time of its discovery, because the publication, filed in 1915, was forbidden by the Government on account of the war, and was only recently released. The method consists of splitting speech up into a spectrum band and transmitting each element of the speech spectrum separately, then reassembling the elements at the receiving end. When it has been generally adopted, each subscriber will be given a number, with probably six figures, in the wireless telephone directory, and on turning the indicator to the six figures of the call of the person he wishes to talk to, and throwing the switch, he will find himself in direct communication with the person he called.

Not only is the brilliant professor interested in developing means of adequate communication between individuals, but his inventions



REGINALD AUBREY FESSENDEN

be redeposited by the consumers at any time; and for the proposal in 1911 to make sun and wind provide all the power needed for mechanical use without dependence upon coal, is as remarkable in appearance and in personality as he is in intellect. He is a huge, bearded giant, well-built, genial, of stately bearing and impressive manners. In describing his discoveries he speaks without a great deal of enthusiasm, but with much precision and detail, in the manner of one describing the work of a third person. He rarely mentions himself in connection with his most remarkable inventions, but discusses them in the passive. Perhaps this reticence about himself and the fact that he is always willing to give credit to his assistants are reasons that he is not more widely known in this country.

In the combined study and laboratory of his beautiful home at Chestnut Hill, Brookline, overlooking the Reservoir, he spends many hours a day with his experiments, among his pieces of apparatus, his photographs, and his books. But he is not always working. He has two hobbies, golf and shooting. The wall in a corner of the big room is covered with

have been a remarkable boon to those who must trust their lives to the sea, especially the turbo-electric drive for battleships, and the iceberg detector. The oscillator shown in photograph C is now used on submarines for telegraphing under water, for detecting other submarines, and for telephoning between submarines submerged to a depth of 100 ft. at a distance apart of 10 miles, and for taking continuous soundings while steaming at full speed.

Professor Fessenden is at the present moment working not at some new radio improvement, but on a device by which one thousand pages of ordinary sized print can be reproduced in a space of a one inch square and read by means of projection on a 6" x 8" screen attached to the arm of a chair, the whole device is so small as to be carried about in an overcoat pocket. By photographing on and fusing into a kind of quartz by a method of his own invention, it is possible to preserve records in perpetuity upon a surface so minute as to be almost indiscernible to the naked eyes.

The man who is responsible for these remarkable inventions, as well as for a system of storing power at an annual cost of three cents per kilowatt hour in banks from which power can be withdrawn, and in which it may

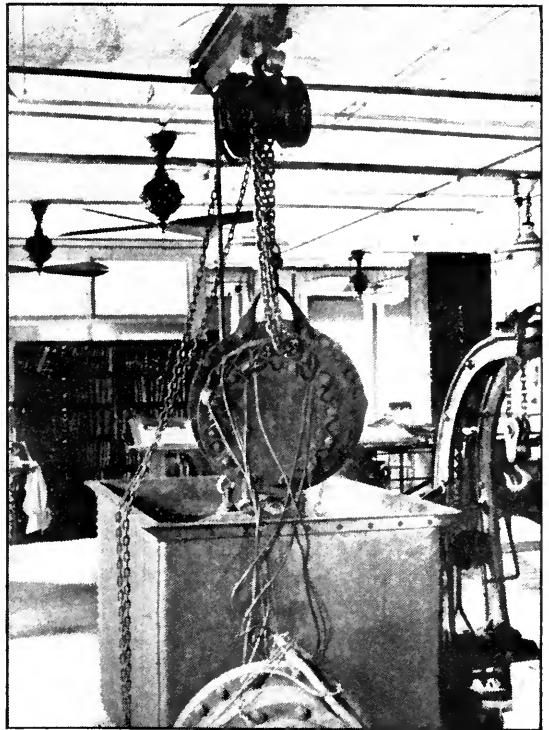

C. Oscillator used on submarines for telegraphing under water, and for telephoning between submarines submerged to a depth of 100 feet at a distance apart of 10 miles

action photographs of famous golfers, and near by stands a bag of golf clubs as though in readiness for a trip to the Country Club. Several guns which he delights to clean as well as shoot are a source of especial pride to him. In addition to out-of-door pursuits, he snatches moments of relaxation now and then, and often an upturned book shows that he has been interrupted in reading "Curiosities of Literature" by Disraeli, or other of his favorite authors.

Although born in Bolton, Canada, in the year 1866, and a volunteer with the First Canadian Contingent, and detailed to the War Office, London, by General Sam Hughes in 1914, he is proud to call himself a Yankee, and explains with pride that the first of his name to live in this country was John Fessenden, an original settler of Cambridge, Mass., whose tan yard was somewhere on the site of the present Harvard College Yard.

At the age of nineteen he was appointed inspecting engineer of the General Electric Company, and later was head chemist for Edison, to whose instructions he attributes whatever success he has had in inventing. He has been professor of physics and electrical engineering at Purdue University, later at Pittsburgh, special agent for the United States Weather Bureau, and consulting engineer for the Submarine Signal Company. Of recent years, however, he has felt it impossible to continue his more public work, and is devoting himself entirely to his inventions and experiments, all of which he realizes are of great practical value and of immense service to the world.

His seemingly superhuman accomplishments have been the result of a life-time of continuous and painstaking effort. As a child he was interested in mathematics. The banking profession, in which he was brought up, offered no incentive to his already inventive type of mind, and science, with its unceasing appeals to the imagination, excited him.

In 1892 he was giving a course in Hertzian waves at Purdue University, and from that time to the present has added one marvellous device after another to the development of wireless communication.

In endeavoring to transmit speech by wireless, he found it impossible with the old spark gap coherer system, because of the lack of two essential requirements, that the waves should be generated continuously and that the receiver should be capable of utilizing them

continuously. In 1899 he started four lines of work for producing continuous waves, first by commutating a continuous current, second by a continuous arc, third by a high frequency dynamo, and fourth by an unstable current. He succeeded in 1900 in first transmitting articulate speech by wireless over a distance of one mile at Cobb Point, Maryland, using a 10,000 cycle per second commutator. Though understandable, the articulation was not perfectly clear. With the development of the continuous arc generation method, he was able in 1902 to reach approximately 12 miles by using an arc frequency of 50,000 cycles per second, producing much clearer articulation. In 1903 in Washington he demonstrated before a number of prominent engineers an apparatus capable of working 25 miles, which was put on the market and tendered to the United States Navy in 1905.

In the mean time he had proceeded with the development of the high frequency alternator and finally constructed three dynamos at the Brant Rock, Mass., station, two of them operating at 50,000 cycles, by using the fields of a previous dynamo failure, and a third operating at 100,000 cycles.

For a continuous receiver, in place of the old coherer which had to be tapped back every time a signal was received, he invented a number of devices, the first of which was the ring receiver mounted on a sensitive microphonic contact, followed by the hot-wire barretter and the liquid barretter. About this time he devised an interesting type of receiver in which a small hot-wire barretter mounted on a small rubber holder fitted inside the ear, invisible wires ran to the hat-band and down the side of the body, permitting wireless telephone messages to be received by a person walking about in the fields several miles from a station.

After building various types of amplifiers, he was able to maintain regular wireless telephone communication between Brant Rock and Jamaica, L. I., with articulation clearer than over the wire telephone lines between the same places, using an apparatus in 1907 which permitted simultaneous talking and listening. In 1906 he had been able to demonstrate to a number of leading scientists the transmission of speech by wireless between Plymouth and Brant Rock, and the relaying of conversation over the regular wire lines.

As the result of tests made by the Bell Telephone Company, contracts were drawn up by

Mr. Fish in 1908 calling for the installation of wireless communication links between Martha's Vineyard and Boston, and for the construction of wireless long distance lines between Boston, New York, Buffalo, and Washington. The contracts were not carried out because the banking interests supplying money for the Bell Telephone Co. decided that the company was expanding too rapidly and revised their policy, in consequence of which wireless telephony for commercial use was delayed for about a dozen years.

Professor Fessenden describes the first transmission of articulate speech across the Atlantic,

which was accidentally accomplished in Nov. 1906. Operators telephoning between Brant Rock and Plymouth were overheard on several occasions by his operators at Machrihanish, Scotland, who identified the voices of the men speaking and sent back several reports giving the exact words of the conversations, which were subsequently verified by the log books of the station.

Since that time the inventor of the wireless telephone has been constantly improving upon it, developing and simplifying it so that it may be adopted for more general use.

New Radio Net for Rogues

William J. Burns Tells Some of the Plans of the Recently Established Bureau of Investigation of the Department of Justice. Radio to Play a Large Part

By DONALD WILHELM

TO BE recorded upon the all-pervading ether as a criminal, that," says William J. Burns, detective extraordinary and head of the Department of Justice Bureau of Investigation, "will be as good as landing behind the bars."

The old-style rogues' gallery is now out of date; we are, Mr. Burns says, on the threshold of a system incomparably more thorough, incomparably swifter, incomparably more discouraging to crime and criminals.

"The Department of Justice Bureau of Investigation," he told me, "is soon to begin using radio."

Radio, he explained, is to be used not only for the detection of criminals but for the prevention of crime. "We are trying to prevent crime," Mr. Burns said. "That will be our greater work."

He added: "We are trying to make this institution function in the interests of the people—for the first time."

He described how the Bureau of Investigation had been, in the main, a kind of service bureau for the Government, whereas now, in ways not heretofore revealed, its new aim is to serve the entire American public in its unprecedented battle against lawlessness—lawlessness, he points out, that is aided and abetted by new and swifter means of transportation, especially the automobile.

His Bureau is now setting up a kind of national and international switchboard. It is to be called a bureau of identification. Its handmaid will be radio. It will use radio, Mr. Burns says, to broadcast even fingerprints!

"We will have registered in the Bureau of Identification," he explained, "the fingerprints of any and every criminal, and of any other person who cares to put himself on record. We will have their photos and descriptions. We will be in touch with every police agency in the United States."

Many police departments are establishing the use of radio—they asked for, and were granted by the Radio Conference, the use of a separate band of waves, for their particular use, for city and state public safety broadcasting. Chicago has found radio useful in detecting stolen automobiles and automobile thieves. Philadelphia is coming into line. Berkeley, California, whose Police Chief, Vollmer, is matching science against crime, has every policeman provided with an automobile and virtually every auto equipped with radio. And other city police departments are equipping not only their motor boats, cycles and automobiles, and even in some instances their patrolmen, with radio but are using it to link up fire department apparatus. The writer's view is that this is only the very beginning; war against common

enemies of society will not stop with this. With apartment houses equipping their suites with radio extensions from a central receiving set; with thousands of city dwellers hitching themselves to radio waves; with virtually every farmhouse equipped with radio to meet the farmer's business needs as well as furnish him diversion; with the American radio chain reaching round the world, and the Signal Corps, Post Office, and other nets being developed to cover every inch of American soil, the future of crooks looks discouraging!

Still more intensively, I believe, radio will be employed for police purposes. At sea we know that when the SOS jams the air, every neighboring ship stands by. On land when a similar SOS jams the air, in any emergency, every neighboring individual will stand by. At sea we have compass stations, a wonderful chain of them, brought into existence to combat submarines. Also we have radio beacons continuously emitting their warnings by radio. And on shore there is no reason why we should not have

Extract of a letter sent by William J. Burns, Director, Bureau of Investigation, Department of Justice, to all chiefs of police.

One of the first observations which Mr. Daugherty made, after assuming the duties of Attorney General, was to appreciate the need of establishing a Bureau of Investigation that would function promptly and effectively and at the same time have the confidence and cooperation of the forces of law and order in each town, city, and state. It is the desire of the Attorney General and myself to bring about this cooperation by a closer relationship between the local police forces of the country and the Bureau of Investigation of this department. In line with this desire, the Attorney General and myself have had several conferences with the representative of the International Association of Chiefs of Police, through the medium of the National Bureau of Criminal Identification, and have obtained suggestions for the effective inaugurating and carrying out of the plans for cooperation. These conferences have been most productive and have led now to the crystallizing of the plan for the establishment of a Central Bureau of Identification in the Department of Justice in which will be placed the fingerprints, photographs, and all detailed information available concerning criminals in this country. This it is hoped will not only be of material aid to the federal government but will be of invaluable assistance to the law-enforcing department of the cities and states.

radio beacons at every cross-roads. Even now these could be provided: If then a murderer—a John Wilkes Booth, let us say—were at large in Ohio or Maryland, say, that man could be caught by radio. His description could be put upon the all-pervading ether without his knowledge. Every apartment, every farmhouse, every gathering point of human beings, and mounted constabulary as well (the Canadian Mounted Police are now experimenting with radio) would have his description. Even now, with our present broadcasting system, any fugitive could be broadcasted pretty thoroughly. If, in addition, by the use of multiplex telephony, for instance, as General George O. Squier suggests, along every highway there were alarm boxes, radio would indeed be the handmaid of the police and of all communities.

We have seen so many cases of fugitives overtaken by wireless on the sea—the first was that of Dr. Crippen, who was caught by wireless en route to Canada under an assumed name, arrested on landing, returned to

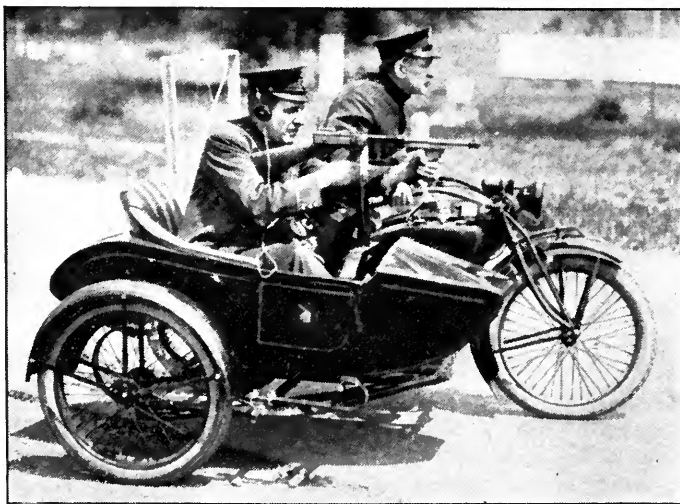

Motorcycle for police, equipped with the Thompson submachine gun and a radio outfit. This is the most modern of all police equipment and is rapidly being adopted by cities all over the country

England and hung—that we accept such events as a matter of course.

Again, it was only the other day that a banker in Dallas, Texas, who wasn't up on radio, walked out of the back door of his bank, a defaulter. He was reported by radio by the Dallas police to Post Field of the Army Air Service. At Lawton, Oklahoma, an amateur caught the word. This amateur spotted his man, reported him. Before the end of the day the defaulter was lodged in the Lawton jail.

Mr. Burns, himself, told me of a case even more sensational.

Into the Westinghouse plant at Pittsburg came a young, well-dressed individual. He represented himself as a committee of one sent by a community organization to borrow a receiving set. He was loaned one of the very best and did not return it. The situation was reported to the local Burns detective agency. After an investigation this young man was broadcasted:

Twenty-four years of age or so, about five feet eight inches tall, blue eyes, a scar on his left cheek, etc. That evening, it so happened, this fugitive was entertaining his mother and some of his friends with his new receiving set. They were sitting by when out of the ether came a flash of the whole situation. The next morning his mother saved her son from arrest by appearing at the Westinghouse offices with saved-up earnings with which to buy the receiving set.

"Radio," Mr. Burns went on, "will be infinitely useful in crime work. Using it, we can add greatly to the strength of a central agency like ours. Criminals can be reported in the various ways heretofore used and also by radio. We can broadcast them. We can use radio to detect mere thieves"—the cry "Stop Thief!" must now have a far wider meaning—"for

notifying people to look out for forgers, so that merchants can be on their guard, and against other kinds of public enemies. We are going to be able to broadcast descriptions of fingerprints with sufficient accuracy to warrant the detention of any suspect until his identity is finally established."

It will be remembered that, abroad, the Belinograph—a Frenchman's invention by means of which photographs, signatures, and the like have been transmitted across the Atlantic—has been developed to transmit fingerprints exactly. Mr. Burns' plan does not look



© Harris & Ewing
William J. Burns, Director of the Bureau of Investigation, Department of Justice

to using the Belinograph. Instead he is devising a new code that can be used more handily and will yet serve the main purpose. With the cooperation of such organizations as the International Society for Personal Identification, he is devising a code that classifies the varying whorls, arches, ridges, and loops in such ways that anyone familiar with the peculiar markings of each individual can tell at a glance whether a suspect belongs within a certain category.

How Radio Came to Independence Kansas

By THOMAS M. GALEY

This is a typical story of how the rage for radio is spreading, community by community, throughout the United States.—THE EDITORS.

OMAR WIBLE brought it. At least it was Omar who opened the gates to it when, on the fifth of last December, he heard over his wireless telephone, the services at the Calvary Church in Pittsburgh, Pa., and the local newspaper printed an account of his experience. The curiosity of the public was instantly aroused, and many local telephone inquiries kept Omar Wible busy vindicating the veracity of the local press.

For about a dozen years before that, to be sure, Hubert Devore had been reading the big spark stations, and one evening about a year ago he was startled by the sound of a human voice in his receivers. It was the operator at the station on Catalina Island in California whom he heard talking, but that startling experience didn't get into the newspapers. So it was Omar Wible's hearing of the church services which gave the craze its first impetus.

Independence is a prosperous town in south-eastern Kansas. Its twelve thousand inhabitants are of average intelligence and education, but only half a dozen boys who owned little home-made sparkers had ever heard, until then, that telephoning without wires was a practical reality. But soon, the word "broadcast" began to be heard, and then the fact became public property that the East was already started on a rampage of radio. Kansas is generally about two months behind the East in experiencing a business boom or depression. This seems to be equally the case with radio, but by the middle of last February it appeared that everyone wanted to "listen in," and by the end of that month the mysterious functions of a variometer or a grid-leak were becoming rather ordinary talk about town, especially where there was a small boy in the family.

Omar Wible had played with electrical apparatus ever since he had attended school in Chanute, Kansas, a dozen years ago. He had

constructed with his own hands, the receiving set with which he heard Pittsburgh, using jelly glasses, "Quaker Oats" cylinders, some wire, and an electric light bulb; at least, that is how the installation looked to a young business man who promptly called to see what sort of an apparatus could enable a man to hear church services 863 miles away.

Omar Wible, whose chief trouble at that time was that he had to make a living beating the drum in a moving picture show every evening during the very time when broadcasting fairly fills the air, went on and built himself a transmitter, using a generator from a junked automobile, so that the whole apparatus cost only about forty dollars. Then he broadcasted a concert by the Girls' Glee Club of Emporia College. Some of the members of the club slipped away to homes where friends, gathered around receiving sets, were eagerly awaiting the concert. The songs were pretty much garbled and the college cheer sounded like a dog fight, but everybody was delighted.

Omar Wible's aerial was tied to the top of a twenty-foot post, and stretched its crooked length from the front curb to the alley. Independence has seen many aerials since, but it hasn't been able to get rid of that feeling of the supernatural, the impossible, which Omar's aerial caused in those who gazed upon it. Even the detector tube, which, after all, only translates the faint impulses caught by the aerial cannot exceed the wonder of it.

About a dozen individuals promptly planned to put in transmitting sets, so they could keep in touch with relatives in Los Angeles or Cape Cod, but that wave of enthusiasm diminished as local knowledge progressed. It finally simmered down to the establishment of a real radio store and a rather costly 1 KW transmitter. To be sure, there is not much genius to transmit, but all the same it is planned to carry church services to every farmhouse within a reasonable radius and occasionally Schumann-



Omar Wible, who heard on his home-made receiving set the services at Calvary Church in Pittsburgh, Pa., 863 miles away, and thus started the craze

Heink or Al. G. Fields may provide the touch of genius. It is thought the local ministers must brace up to compete with the beautiful services from Pittsburgh and Detroit.

By the last of January it was possible to get KDKA in Pittsburgh and Fitzsimmons Hospital in Denver every night, at least when Bob Flint was not sending crashes of energy to Chester Pendarvis at Elk City eighteen miles distant.

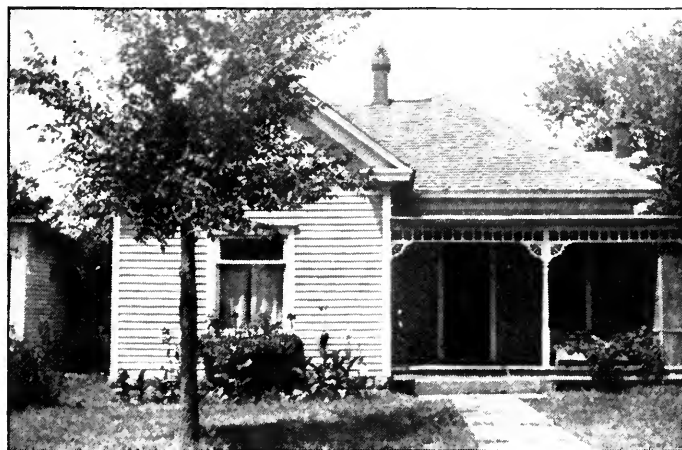

Home of Omar Wible whence he broadcasted the first concert and first sermon in Southeastern Kansas on a transmitting set that cost him only forty dollars

A month later, "listeners-in" heard a new call and a voice announcing the *Detroit News*

Station. The service from this station came regularly with startling perfection. There were now three big stations which could be depended upon. Then Dallas came in, and, night after night, new ones appeared; notably Schenectady, Indianapolis, and Atlanta. So many attempted to use the narrow band, about 360 meters, that KDKA was crowded out.

For weather, market reports, and good music, the big cities are depended upon. Several fans even sent contributions to the *Detroit News* to help finance the Symphony Orchestra concerts so marvelously broadcasted.

The dramatic effect of the radiophone is far more profound in the rural districts of the West than in New York City, and the time will arrive with startling speed when every farmhouse will have a set.

Already one hears grumbling in the Eastern cities about the character of the programmes of certain of the big stations, so exacting and critical is the public mind in a big, conventional city. But our Western listeners are less critical of the programmes from the East, and the anticipation of marvelous broadcasting developments next winter is creating a rapidly growing interest. A sound that becomes each day more familiar in the Central West is: "Say, where can I get some bulbs?"

The sewing machine peddler who "sells" the farming districts in his little "whoopie" will be crowded off the road by the radio

peddler with most any sort of a set from a dollar up. It is on the farm where the best receiving success will prevail, being far from high tension lines, dirty street car commutators and power houses. It is to the lonely farms of the Central West that the radiophone will bring a new interest, an interest which

may hold the ambitious farm boys, and the farm girls as well, from flocking to the city.

How to Begin to Enjoy Radio

By CAPTAIN LEON H. RICHMOND, SIGNAL CORPS, U. S. A.

Editor, Technical Training Literature, Office Chief Signal Officer

Captain Richmond, who was Professor of Physics at Western Maryland College before the war, was commissioned in the Signal Corps at the outbreak of the war. After passing through various instruction camps, he was assigned to the Royal Navy (British) Flying Field at Cranwall, England, where he worked with Lt. Commander J. M. Robinson (British Navy) in developing a radio direction finder and other radio apparatus for airplanes. Upon the completion of this duty, and after a short time at an American flying field, he was assigned to duty at the Army Signal School, Langres, France, where he was in charge of the Radio Department at the signing of the Armistice. For the last year and a half, Captain Richmond has been on duty in the Office of the Chief Signal Officer at Washington.—THE EDITOR.

II

WHenever it is desired to receive a certain transmitting station, the radio receiving set must be *tuned* to that station. This is done by turning the knob or knobs on the receiving set. It is the purpose of this article to tell just what is done when these knobs are turned, i. e. why turning the knobs tunes the set.

OSCILLATING CURRENTS

A RADIO wave is produced by an electric current which moves first in one direction along a wire, then moves in the opposite direction. Such a current is called an *alternating* current, the word alternating describing the change in direction of the current. When the alternations of current (changes of direction) take place thousands of times per second, the term *oscillating* current is used to describe it. Radio waves used in present day radio communication are produced by electric currents which oscillate with a frequency of between 10,000 and 6,000,000 times per second. This oscillating current sets up radio waves of the same frequency. (See first article of this series for relation between frequency and wavelength.) The radio wave, coming to your receiving set, sets up in it oscillating currents, IF THE RECEIVING SET IS TUNED to that frequency (wavelength).

CONDITIONS FOR OSCILLATIONS (FREE)

A BETTER understanding of tuning can be had if we compare it with something with which we are all familiar. Let us first consider what happens when a weight is put

on a spring balance. If set in motion, the weight will move up and down, that is, it moves alternately in one direction and then in the other, without any outside aid. A little thought about it will show that there are two factors which cause this up and down motion. The weight is one factor, the spring is the other. When started in downward motion, the weight keeps moving beyond the position where the two will finally come to rest, but as soon as it gets beyond the point of rest, the spring begins pulling back. The further the motion from the point of rest, the more the spring pulls until finally the weight stops moving down and starts moving up, being pulled back by the spring.

We can get the same effect in another way. It would be well to do this experiment to fix the idea firmly in your mind. Take the blade of a hack saw or some similar object and fasten it in a vice allowing some of it to project. By some means fasten a weight to the projecting end. Pull the end to one side and let it go. It will vibrate back and forth. Again the weight keeps it moving beyond the point of rest and the springiness of the hack saw blade pulls it back toward the point of rest. Try this experiment with a hack saw blade, a kitchen steel knife, or a spatula.

The condition under which any system will oscillate is clearly set forth in the above experiment. To state it again, it is that there must be present something which will keep the system moving beyond the point of rest, and there must also be present something that will pull the system back toward the point of rest, the pull becoming stronger the farther the displacement from the point of rest. When

these two factors are present in a system, it is seen from the experiment that the system, when once set in motion, will vibrate or oscillate of its own accord.

It is evident then that if we wish an electric current to flow of its own accord to and fro (oscillate) in a circuit, there must be introduced into the circuit, each of these two factors. One of these factors is called *inductance*; the other factor is called *capacity* (sometimes called capacitance). The fundamental idea that I desire you to get now about inductance is this: When inductance is present in a circuit it tends to prevent any *change* in an electric current. Thus when a current tries to die away the inductance of a circuit will try to prevent it from dying away. Inductance acts like a weight in this respect. The fundamental idea I desire you to get about capacity is this: When capacity is present in a circuit it will store up electricity, but as soon as it begins to store some it tries to get rid of it. The more electricity that it stores, the harder it tries to get rid of it. Thus it is seen that capacity of a circuit corresponds to the springiness of the hack saw blade.

Let us represent, as in Fig. 1, a circuit having inductance and capacity and study it. Capacities A and B are equal to each other.

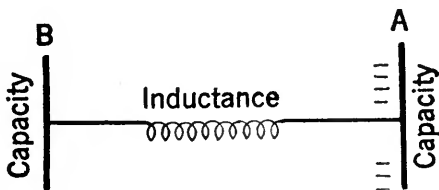

Fig. 1

By some means let us put a charge upon the capacity represented by A in the figure. This charge is shown by the minus signs, which represent the small particles of electricity called *electrons*. As has been noted, the capacity *TRIES TO GET RID* of its charge and is able to do so, as there is a circuit leading to the other capacity. The electrons pass along the wire to the capacity B thus making a current through the inductance. If it were not for the inductance, when the capacity B had received half of the electrons that were on capacity A, the electrons would stop moving, for capacities A and B would each be trying to get rid of their electrons with equal force. But the electrons are moving from A to B and hence there is a current flowing. The inductance now comes into play and *PREVENTS THE CUR-*

RENT FROM DYING AWAY, hence causing all the electrons on A to move over to B. The conditions are exactly the same as they were at first and exactly the same events take place with the exception that it is now capacity B which is charged and which gets rid of its electrons. This to and fro movement will continue until the energy dies away by wastage. The to and fro movement of the electrons is an oscillating current.

Thus it happens that if a circuit contains inductance and capacity, an electric current will oscillate in the circuit when energy has been supplied. This is the exact counterpart of a mechanical system represented by the hack saw blade and weight which has elasticity (springiness) and mass (weight). The reader should compare step by step the action that takes place in the mechanical and the electrical systems. He will find that the action of one is similar to that of the other.

NATURAL FREQUENCY AND RESONANCE

NOW let us go back to the hack saw blade and weight experiment and notice another fact about it. Start it vibrating and notice the number of vibrations per second. Change the amount of weight on it and cause it to vibrate again. The number of vibrations per second is different from what it was. Change the stiffness of the blade (make it longer or shorter). Again the number of vibrations per second have been changed. What we have learned is this: that this mechanical system has a *NATURAL FREQUENCY OF VIBRATION* which may be changed by changing either the stiffness of the blade or the weight attached or both.

Electrical oscillations are exactly the same. In Fig. 1 the number of to and fro motions of the electrons (oscillations) depends upon the value of the inductance and capacity in the circuit. Changing either one or both of these will change the number of oscillations per second. This may be summed up by saying that an *ELECTRICAL CIRCUIT CONTAINING AN INDUCTANCE AND CAPACITY HAS A NATURAL PERIOD OF OSCILLATION, DEPENDING ON THE VALUES OF THE INDUCTANCE AND CAPACITY*. Every receiving set has inductance and capacity. What you do when you turn the knobs on the receiving set is to change either the amount of inductance or capacity in the circuit. (On some sets there are also knobs used to control the current supplied the vacuum tube or tubes.)

Thus the circuit can be adjusted so that its natural frequency is any value desired (within the limits of the set.)

TUNING then means that you adjust the natural frequency of your receiving circuit so that it is equal to the frequency of the radio waves you desire to receive.

Why must this be done? Because the amount of energy in the received radio wave is so small that, if the receiving circuits were not tuned, there would be no effect produced by the waves. It is a case of *resonance*. We are all familiar with resonance effects though we may not call them by that name. When you swung your playmate you used the principle of resonance. You timed your pushes so that they would come just at the right instant. By doing this you were able to make the swing go very high, using only slight pushes. The swing had a natural period of oscillation; by timing your pushes (tuning them, so to speak) you got a large effect from a small amount of energy.

Examples of resonance are numerous. The fool who rocked the boat knew about resonance. He timed the swaying of his body to the natural frequency of oscillation of the boat, thus overturning it. He secured a large effect from a small amount of energy. Have you noticed, very often when a piano is being played that, as a certain note is struck, the glass in a picture frame or some other object will rattle. This is because the object has a natural period of vibration equal to that of the note. The two are "in tune" and thus the small amount of energy in the sound wave produces a large effect.

Thus, then, when any system which has a natural period of oscillation or vibration of its own is acted upon by a very feeble force that has the same frequency, the effect produced by the feeble force is large. The radio wave from a distant station has only a feeble energy when it reaches your station. It has a certain definite frequency. If you desire that your receiving set be affected by the feeble energy in the radio wave, you must adjust your circuit or circuits so that their natural frequency is equal to that of the radio wave. The receiving circuit and the radio wave are then in resonance, hence the latter produces a comparatively large amount of energy in the receiver. This process of adjusting the natural frequency of the receiving set to equal that of the desired radio wave is called tuning.

Now we are ready to get a better understanding as to why we can have more than one radio message in the ether at the same time without interference. Suppose one station is transmitting on a wavelength of 300 meters and another on a wavelength of 600 meters. Their frequencies are then 1,000,000 and 500,000. Now if you adjust the natural frequency of your circuit to be 500,000, it will be in resonance with the 600 meter wave and out of resonance with the 300 meter wave. The 600 meter wave will affect your receiving apparatus; the 300 meter wave will not unless the latter is very close by. You are tuned to 600 meters. You did it by adjusting the values of the capacity or inductance in your receiving set.

From the above explanation it might be thought that your receiving set will respond to one frequency (wavelength) only. Unfortunately this is not the case. There is a *band of wavelengths* to which your receiving set will respond. The width of this band depends upon the receiving set. It may be that if you tune to 600 meters your set will respond almost equally well to any radio wave whose length is between 510 and 690 meters. This is a variation of 15 per cent. on either side of the 600 meters. This is not very *selective* tuning. It is to be noted that any station transmitting on a wavelength between 510 and 690 meters would cause interference if the waves had nearly the same amount of energy as the waves you were trying to receive. Some receiving sets are capable of better selection—sharper tuning. A set that will respond to wavelengths between 570 and 630 meters (5 per cent) when tuned to 600 meters is a fairly sharply tuned set. Such a set diminishes the possibility of interference.

This then is a limitation on the number of ether waves that can be utilized without interference. Another limitation lies in the fact that a transmitting station radiates an *impure* wave. That is, instead of radiating its energy at one wavelength, it radiates a band of wavelengths on either side of its main wavelength. Thus we have the transmitting station radiating a band of wavelengths and a receiving station responding to a band of wavelengths. This limitation upon a limitation greatly reduces the number of messages that can be in the ether without producing interference at the receiving station. Rapid progress is now being made in the reduction of the width of both

of these bands, thus increasing the number of wavelengths available for simultaneous communication.

In the receiving set the band can be greatly narrowed by the use of two selective circuits and this is a common arrangement. The first circuit selects a band of frequencies (wavelengths) from all the radio waves present in the ether. The second circuit selects a very narrow band of frequencies from those present in the first selective circuit. This double selection is very effective as the effect is cumulative.

A TYPICAL RECEIVING CIRCUIT

A TYPICAL receiving circuit is shown in Fig. 2. All the symbols used are those customarily employed. The reader should fix them firmly in mind, for they are not usually labeled in diagrams. Wherever an arrow appears it signifies that the quantity represented by the symbol through which it passes or to which it points is variable. Thus a coil represents an inductance; the arrow, A, pointing to the coil means that it is variable. Two straight lines of equal length near and parallel to each other represent a condenser, which is the name of the instrument that furnishes a capacity. An arrow through the lines means that the capacity is variable. The long arrow through the two inductances, one in either circuit, means that the strength with which the

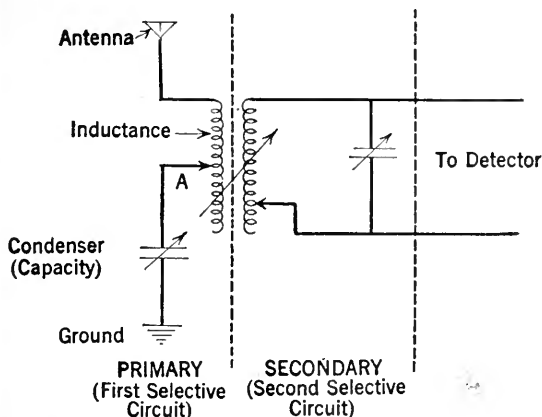

Fig. 2

primary circuit affects the secondary circuit may be varied at will. The method of doing this will be explained in a later article.

The dashed lines are not a part of the circuit but simply indicate its division into two selective circuits, each of which, you must notice

contains an inductance and a capacity. It is only a tuner that is shown; the detector and phones not being included in the diagram. Note that there are five variable quantities represented in this tuner; that means that there are five knobs or handles to adjust. Your tuner may not be like this one, it may have fewer variables, but it will certainly have some of the features of this typical tuner. For instance, your tuner may have only one selective circuit and it may have only one variable quantity in this circuit. Again your tuner may have two selective circuits with only one variable in each and no means of adjusting the effect of the one circuit or the other. Other combinations are possible also.

INDUCTANCE AND CAPACITY

LET us conclude this article by describing how an inductance and capacity are made and how they are made variable. We will first consider capacity.

Capacity may be likened to a tire. Compare a bicycle tire and an automobile tire. Suppose we take 4 cubic feet of the air in a room and pump it into an automobile tire and also pump another 4 cubic feet into a bicycle tire. The same amount of air has been put into each tire but the results are different. The pressure in the bicycle tire is, say, 100 pounds per square inch. This means that the air inside the tire is trying to escape with a force of 100 pounds. It also means that, in order to blow up the tire, a force just greater than 100 pounds per square inch must be applied. But the same amount of air in the automobile tire causes a pressure of only, say, 20 pounds per square inch. The air inside is trying to escape with a force of only 20 pounds, and it required a force of only a little more than 20 pounds to put it in the tire. So in electrical capacity, the amount of capacity determines the force (electromotive) with which a certain quantity of electricity will try to escape and also the force needed to put that amount of electricity into the capacity. Using the same amount of electricity, the larger capacity requires less force to be charged and exerts less force trying to discharge itself.

In Fig. 3-A there are shown two conducting plates placed close together but separated by a nonconductor.

The plates may be of any metal and for the sake of compactness they are usually a number of small plates all joined together as shown in

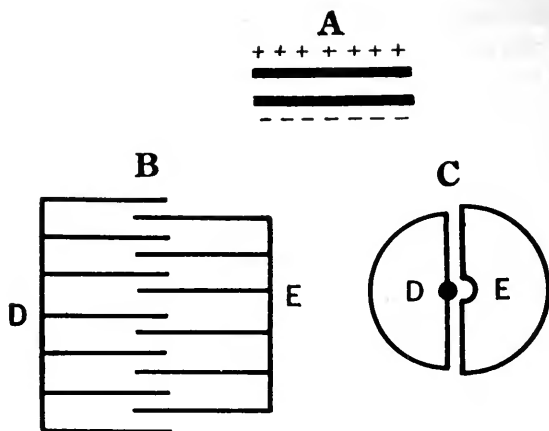

Fig. 3

Fig. 3-B. This is equivalent to one large plate. The material between the plates may be any nonconductor, but the most common materials used are oil, air, mica and paraffined paper. The whole apparatus is called a condenser. Fig. 3-B shows how a condenser may be made variable. The figure shows only a small portion of one set of plates opposite to the other set. This gives a small capacity. If the plates are moved toward each other, larger areas of the plates are opposite, thus increasing the capacity. In ordinary use each set of plates is

made semi-circular in shape. A shaft passing through the movable plates enables them to be rotated so that all or any part of the plates can be brought between the plates of the stationary set, thus varying the capacity. Such an arrangement is represented in Fig. 3-C.

An inductance is made by winding wire in a coil. The more turns of wire in the coil, the

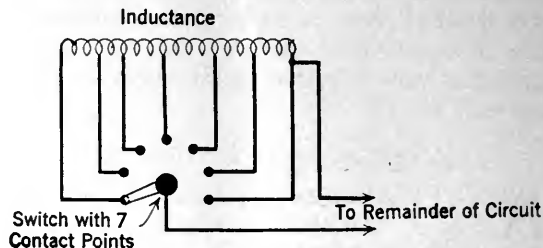

Fig. 4

greater the inductance. A variable inductance is made by winding a coil and connecting leads to it at every few turns. These leads or taps are run to studs, any of which may be used. In this way a variable number of turns and hence a variable inductance may be included in the circuit. Fig. 4 clearly shows the arrangement. A further discussion of inductance will be given in a later article.

A Simply Constructed and Operated Short Range C. W. Transmitter

By ZEH BOUCK

THE majority of battery phone sets are theoretically inefficient. The difficulty generally lies in dissipating a proportionately large amount of energy from the antenna without stopping oscillations. For this reason the Colpitts, a rather critical circuit at any time, is almost altogether inoperative from a low voltage supply except with an aerial of certain definite inductance and capacity. Many B battery phones employ an inductively coupled system to govern the transference of energy from what is often the split filament circuit. But here again if a relatively large antenna current be momentarily indicated the comparatively feeble oscillations will be smothered.

It was altogether by accident that I hit upon the following circuit which employs the antenna as an integral part of the oscillating system, and which radiates exceptional power in proportion to a low input.

The circuit is fundamentally that employed by the British Government during the war, and one that I have very successfully used in a five-watt set with an oscillator and modulator. While experimenting with the effect of different positive and negative grid potentials on the space current of the modulating tube, I accidentally clipped eighty volts in B battery, (working blindly in the rear of the panel) to the plate of the oscillator. The current was choked through the modulation transformer,

and as I turned up the filaments, preparatory to throwing in the generator, I was surprised to see the radiation meter jump to slightly under one tenth of an ampere. A little investigation and experimenting resulted in the set I shall describe.

While I intend giving details of the electrical construction of the apparatus, the purely mechanical end, such as panel design and mounting, will be left to the taste and ingenuity of the experimenter. The set is in no way critical, and the builder need only approximate my directions with the single exception of tapping the grid coil.

C_1 is a variable condenser of a capacity no less than .001 and preferably a .0015. With some antennas and tubes it is possible to eliminate the grid condenser C_2 and the leak R_1 , merely shorting over; but in the majority of cases better results are obtained with them in the circuit. C_2 is a standard grid condenser, without leak, of the type sold by most dealers for thirty-five cents. I found the customary receiving grid leak of one or two megohms too high a resistance for transmitting purposes and I substituted a variable one of my own design that gave very satisfactory results. (Fig. 1.)

It is of the pencil mark type but the wide contacts and their proximity make very low resistances possible. Three-quarter inch brass

strips were used and bent as indicated, i.e., so that the separation between them was about one eighth inch and the machine screws passing through the ends would support and connect the grid condenser on the other side of the panel or base. A piece of very fine sandpaper, scraped so that it will take pencil lines without powdering, makes an excellent marking surface and is slipped under the blades. For the original adjustment the paper should be fairly well blackened.

The reactance or choke, X , may take almost any consistent form, from an L200 honeycomb coil to the bobbins of a telephone receiver. If desired it may be wound with two hundred turns of number thirty single cotton-covered wire on any convenient spool. As it is merely a high frequency choke, designed to prevent the high voltage battery from shorting the condenser C_1 , the core indicated in the diagram is not necessary.

L_1 , the main antenna inductance (Fig. 2), is wound on a four and a half inch (outside diameter) tube. Number twenty single or double cotton-covered wire may be used for all windings. The forty turns are tapped every fifth turn from the inside, and brought down to binding or clip posts on the lower periphery of the tube. The upper half of the winding is insulated with two layers of empire cloth or tape over which the grid inductance, L_2 , of twenty turns is wound. The taps, which are brought out directly in short lugs, begin at the tenth turn from the top and continue from there on with every alternate turn. In operation the upper end of the main inductance is connected to condenser C_1 so that the grid winding is always over the active part of L_1 . The modulating coil, L_3 of one, two, or three turns shunted by a microphone, is wound over the grid inductance, its ends twisted or taped together. The number of turns in this last inductance varies with power and transmitters, but generally a single turn will suffice, giving the best modulation without blocking the tube.

Any amplifying bulb of sufficient hardness may be used as an oscillator; a state of hardness being evidenced by a total absence of blue or purple haze when the filament is lighted and the plate potential applied. For the most consistent work the excellent results obtained from the Western Electric V. T. 1, commonly known as a "J" tube, will more than compensate for the expense and trouble of securing one.

The microphone is of the conventional type,

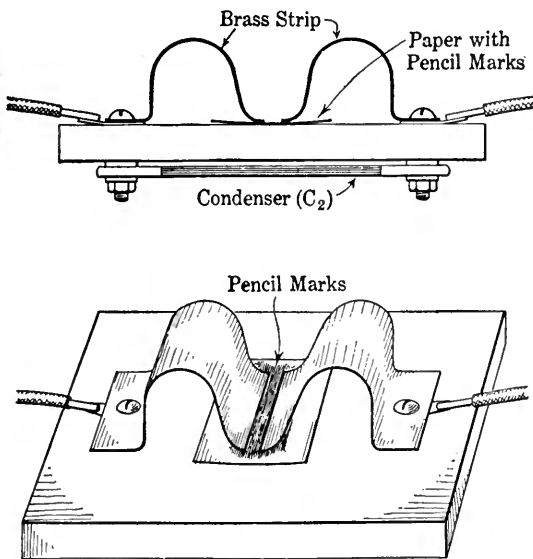

Fig. 1 illustrates the method used for making a variable grid-leak. By sliding the pencil-marked sandpaper under the brass clips different resistance values may be obtained. The upper illustration merely shows the location of the grid condenser

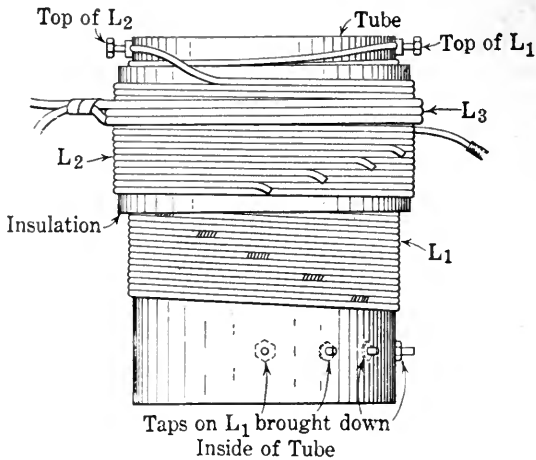

Fig. 2. The method of winding inductances is clearly illustrated here

generally, with the exception of nine points of the law, the property of the Bell Telephone Company. Trial will often show superior modulation with different transmitters of the same make.

The B battery is most conveniently built up of from five to ten twenty-two volt blocks, and it is a commendable precaution to disconnect them when not in use, thus preventing any possible short through condenser C_1 .

The system is principally a tickler one and a theoretical explanation of its functioning will be conducive to more intelligent operation.

As the A and B batteries are thrown in, the plate current rises (not instantly, as it is retarded by the reactance in L_1 through which it flows) from zero to maximum, and with it a magnetic field about L_1 , which, due to its proximity, cuts L_2 . If L_2 is connected in the correct direction (determined by experimentation) the current induced in it through the cutting of its turns by the lines of force from L_1 , will place a negative potential on the grid of the tube. This negative grid voltage repels the electrons (electrons being minus charges, and like charges repel each other) permitting fewer of them to complete their journey from the filament to plate. As the plate current (that current traveling through L_1 and which originally set up the magnetic field) is directly dependent on the intensity of the electron stream, it will decrease, with a corresponding fall of the magnetic flux. As the lines of force withdraw, L_2 is now cut in the opposite direction with a reversal of its current and the charge on the grid. The electrons are again permitted to pass, the plate current rises

(coincidentally the magnetic field) and the whole operation is repeated, in the case of a two-hundred meter wave, one and one half million times a second.

But this rise and fall of flux *also cuts L_1 itself*, inducing therein a high-frequency current which radiates energy from the antenna in the form of electro-magnetic and static fields.

For preliminary tuning the microphone is disconnected and a hot wire or thermo-couple meter (preferably the latter) reading from zero to two hundred and fifty milli-amperes is placed in series with the antenna.

The aerial and plate should be connected to the thirty-turn tap, and sixteen turns clipped in the grid circuit. If no radiation is indicated with the filament burning slightly above normal brilliancy (this is usually necessary when using amplifying tubes for transmitting) L_2 should be reversed. The plate and grid taps and condenser C_1 are then varied until the greatest radiation is secured. (From 50 to 200 milli-amperes.) The wave length may be altered by varying either the antenna tap or condenser C_1 without any alteration being made in the other adjustments, a wave meter being used at this stage of operations. With some tubes the grid potential as determined by the leak R_1 will be found critical.

Connections for buzzer modulation are shown in Fig. 3, and straight C. W. (continuous wave) may be employed by inserting a key in the positive or negative lead of the high-voltage battery. When transmitting with one of these two systems, the microphone circuit,

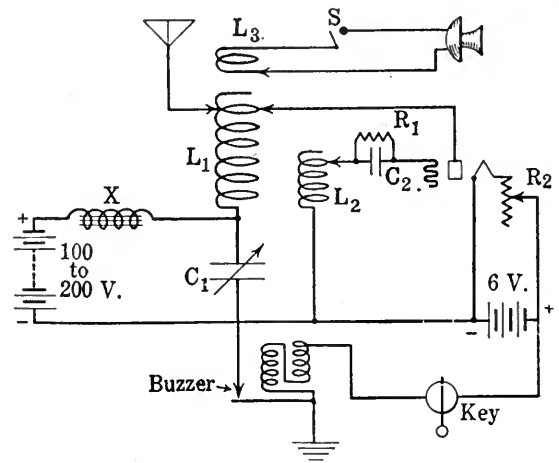

Fig. 3 is a schematic wiring diagram of the complete short range wireless telephone transmitter employing a receiving vacuum tube and B batteries

which absorbs considerable energy, should be opened at the switch S.

With the exception of the radiation meter and the microphone, the set is completely constructed of receiving parts and, including high-voltage batteries and tube, should not

cost more than thirty-five dollars. The range, is, of course, dependent on many factors, not the least of which is antenna and geographical location. But with two hundred volts on the plate, consistent communication of twenty miles on C. W. is not phenomenal.

Our Amateur Radio Reserve

MAJOR PAUL W. EVANS, Signal Corps

Chief of Training, Office Chief Signal Officer, U. S. Army

THE Signal Corps is that part of the United States Army whose duty it is to handle communications. It is a small corps, being only about two percent. of the whole Army. Several books have already been written about the work of the Signal Corps during the war, but it is the object of this article to tell about the work of the Signal Corps in time of peace, and only that part of the work which deals with Radio.

One job of the corps is to keep up the communications for the Army, and another is to prepare for war. Keeping up the communications of the Army is no small task. Aside from the telephone service at all camps and posts, the Alaska cable between Seattle and Valdez, and the various telegraph lines, there is the radio communication between the various headquarters. The Army in the United States is grouped geographically into nine corps areas. Each corps area has a headquarters, and each one of these headquarters is under the direct control of the War Department in Washington. Hence the Signal Corps has a large station in Washington which communicates with a station at each corps area headquarters. These latter stations are at or near Boston, New York, Baltimore, Atlanta, Indianapolis, Chicago, Omaha, San Antonio, and San Francisco. They form what is known as the Army Net. All stations are continuous wave stations and operate on wave lengths between 1000 and 3000 meters. Each corps area headquarters has supervision over the various stations which are located at posts and camps within the corps area. This forms what is known as a Corps Area Net, of which there are nine. The stations, within the corps area nets are not all alike, due to the fact that the demands of

economy have retained in service many older type spark stations and also due to the fact that different sized camps, posts, or organizations each require their own particular type of station which is adapted to their needs. Thus, a long established army post may be found operating the same old spark set which has given good service for the last ten years, while a mounted organization in the field may be found equipped with the latest type of portable continuous wave set.

In preparation for war, the Signal Corps is of course constantly engaged in training its own men, sending them to the famous training school at Camp Alfred Vail, New Jersey, and fitting them in general to become better operators, better electricians, and better radio engineers. It also supervises the instruction of the Signal Corps Units of the National Guard and the Organized Reserve. These organizations go into camp every summer, where they receive special instructions in the field with the latest types of army signaling devices, demonstrated by picked troops from the Regular Army.

At eleven selected electrical engineering colleges in the United States, there is in existence what is known as a Signal Corps Unit of the Reserve Officers' Training Corps. Here electrical engineering students are given special training in army signal work, and when they are graduated by the university they are given commissions as second lieutenants in the Signal Officers' Reserve Corps. Each one of these Signal Corps Units is under the direct command of a selected Signal Corps officer from the Regular Army.

The Great War served to bring home to the people of the United States an important bit

of knowledge that has been known to military men for many years, namely, that success in a great war is dependent not only on training, military knowledge, and wealth, but on the *Man Power* of the nation. In a great war of

saying goes. A large percentage of amateur operators would become impatient at the delays attendant to recruiting specialists and would rush off and enlist to carry a rifle or swing a pick.

In realization of this, the Chief Signal Officer, General George O. Squier, has directed that effort be made to bring the radio amateurs of the country into some sort of an organization so that their names and relative abilities may be known. The organization is known as the Amateur Radio Reserve, and the work is being carried out by the Signal Officer in each one of the corps areas. When an amateur joins this organization he does not enlist in the Army. His allegiance is taken for granted, and he is under no obligation to the United States other than that of the average citizen. He sends his name in to the Signal Officer of his corps area, signifying his interest in radio work and his desire to ally himself with the Signal Corps. The Signal Officer writes to him, informing him of the schedule and wave length of the broadcasting station at corps headquarters. In many corps areas the Amateur Radio Reserve have held regular meetings and have formed a permanent organization under their own elected officers. At each corps headquarters there is a radio expert who is able to answer questions, give instruc-

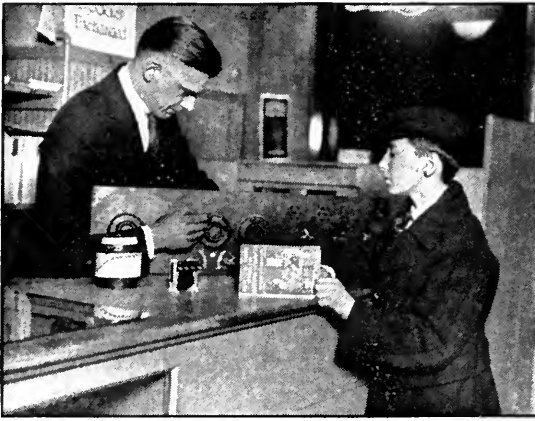

© Underwood & Underwood

Young America is learning to make its own radio equipment. School boys form a great percentage of the radio fans. The growth of this tendency means more and better Reservists—eventually, better citizens

to-day, the nation who is victorious must exert the last ounce of energy and must utilize the last available man.

If the United States were to go to war tomorrow, then what would be the work of the Signal Corps, and what part would Radio play in that work? In the first place, there would be needed many thousands of radio operators. The number of trained Signal Corps operators now enlisted in the Regular Army, National Guard, and the Organized Reserve would not be nearly enough. The number of operators now holding commercial licenses and jobs on commercial stations would not by any means make up the deficit. The country would have to depend upon the amateurs to fill the breach. Every available amateur would have to be considered as a potential operator for the Army of the United States or some other combatant force. Thus we see what *Man Power* means from the standpoint of radio work.

To try to select these men after the nation had been called to arms would result in considerable confusion and loss. The thousands of local draft boards would be so busily engaged in picking out experts of various trades for each of the various arms of the Service that many men, well qualified as radio operators, would become "lost in the shuffle," as the



By means of this clock-work arrangement, a buzzer, key, a dry cell or two, and a pair of telephone receivers the youth of to-day learns the International (Continental Code). He not only fits himself for a place in the "Reserve" or a position in radio, but actually secures much enjoyment which others miss

tion, and assist the amateur operators in many ways. Sometimes these instructions are sent out by radio and sometimes by mail. Although this organization is only a few months old, it

has become surprisingly popular, and in one corps area alone, that around New York, the number of member stations has reached almost a hundred.

Many amateurs have written in to the Office of the Chief Signal Officer in Washington, or to their congressman, requesting that they be sent pamphlets on signal work. The economy of public money has forced the Signal Corps to curtail its printing bill, and no general distribution of these pamphlets can be made. They can be obtained by purchase, however, from the Superintendent of Documents, Government Printing Office, Washington, D. C., at a very small cost, usually about ten cents for each pamphlet. Among the pamphlets which will be of special interest to beginners are:

- Radio Communication Pamphlet No. 1, entitled "Elementary Principles of Radio Telegraphy and Telephony";
 - Radio Communication Pamphlet No. 2, entitled "Antenna Systems";
 - Radio Communication Pamphlet No. 20, entitled "Airplane Radio Telephone Sets";
 - Radio Communication Pamphlet No. 28, entitled "Wavemeters and Decremeters";
 - Training Pamphlet No. 1, entitled "Elementary Electricity" (15 cents).
- A larger book, Radio Communication Pamphlet No. 40, entitled "The Principles Underlying Radio Communication", came off the press about April 1, and is sold for \$1.00 by the Government Printing Office.

Since there are many amateurs who may desire to join the Amateur Radio Reserve, there is given below a list of the Signal Officers

GOOD MATERIAL FOR OUR "RADIO RESERVE"

Seventeen-year-old R. E. Leppert, Jr., of Harrison, N. Y. and his eleven-year-old sister, Vera, in a car that he designed, with a complete radio outfit designed and built with his own hands. He found the wreck of an old Ford in a ditch by the roadside and persuaded his father to buy it for the parts. Then he got new wheels and designed the body, which he had a tinsmith make. He began with radiotelephony three years ago, trying a simple crystal outfit first. Since then he has made many outfits, each an improvement over the previous one

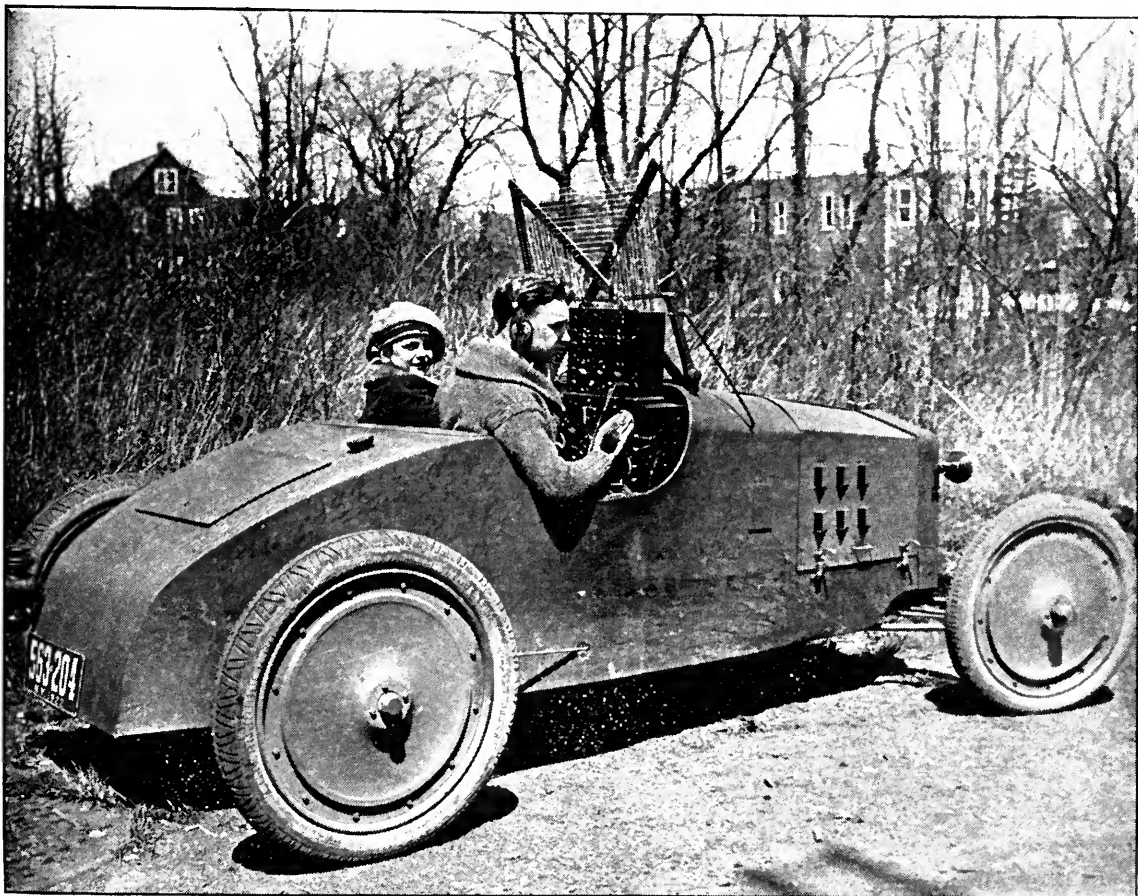

© Ewing Galloway

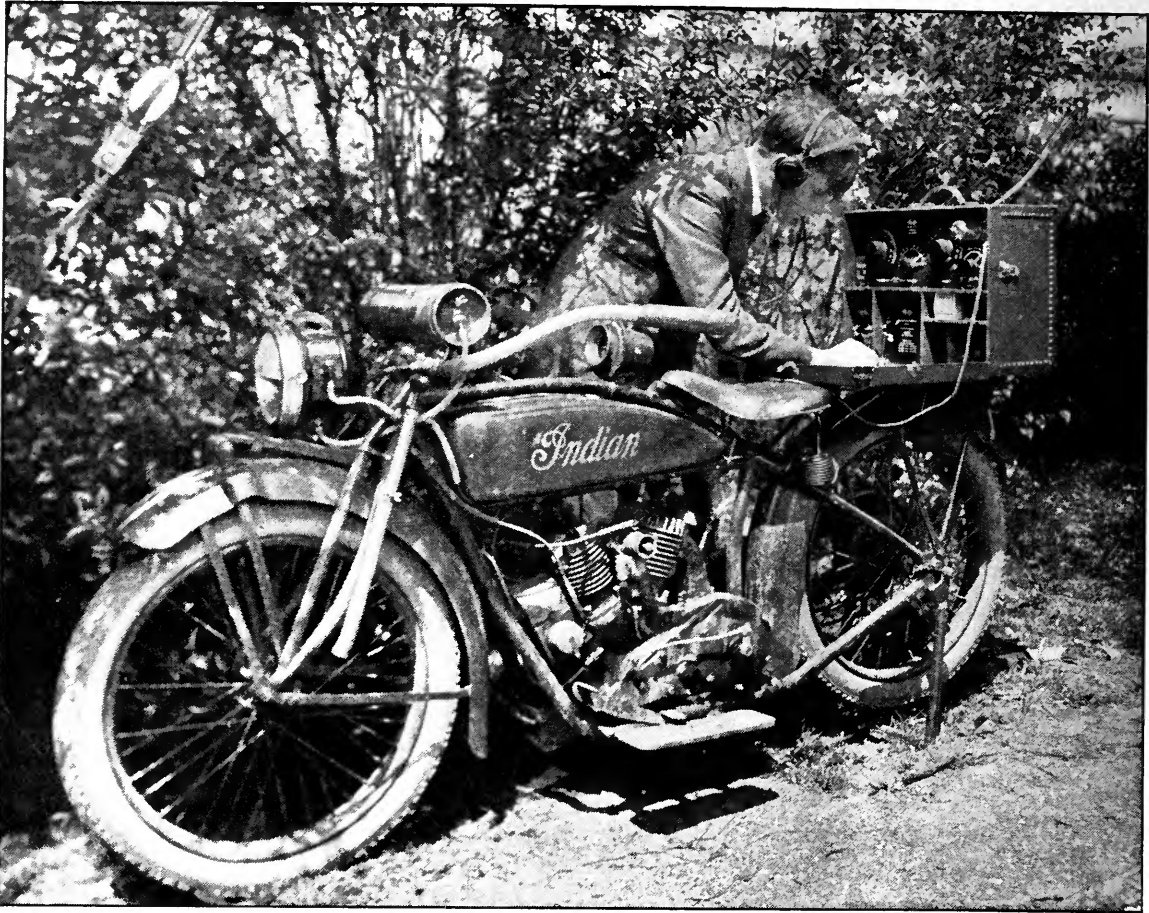

By means of this portable transmitting and receiving set, Radio reservists are able to communicate with each other and with headquarters while en route

of the various corps areas, with the states included in each area:

Signal Officer, 1st Corps Area, Army Base, Boston 9, Massachusetts. States of Maine, New Hampshire, Vermont, Massachusetts, Rhode Island, and Connecticut.

Signal Officer, 2nd Corps Area, 39 Whitehall St., New York City. States of New York, New Jersey, and Delaware.

Signal Officer, 3rd Corps Area, Fort Howard, Maryland. States of Pennsylvania, Maryland, Virginia, and the District of Columbia.

Signal Officer, 4th Corps Area, Fort McPherson, Georgia. States of North Carolina, South Carolina, Georgia, Florida, Alabama, Tennessee, Mississippi, and Louisiana.

Signal Officer, 5th Corps Area, Fort Benjamin Harrison, Indiana. States of Ohio, West Virginia, Indiana, and Kentucky.

Signal Officer, 6th Corps Area, 1819 West Pershing Road, Chicago, Illinois. States of Illinois, Michigan, and Wisconsin.

Signal Officer, 7th Corps Area, Fort Crook, Nebraska. States of Arkansas, Missouri, Kansas, Iowa, Nebraska, Minnesota, North Dakota, and South Dakota.

Signal Officer, 8th Corps Area, Fort Sam Houston, Texas. States of Texas, Oklahoma, Colorado, New Mexico, and Arizona.

Signal Officer, 9th Corps Area, Presidio of San Francisco, California. States of Washington, Oregon, Idaho, Montana, Wyoming, Utah, Nevada, and California.

Radio Fog Signals and the Radio Compass

IN THE radio fog signal station and its complement, the radio compass, the mariner has found a new and powerful weapon to use against his ancient enemies—fog and thick weather.

On May 1, 1921, the Bureau of Lighthouses placed in commission in the vicinity of the port of New York the first three radio fog signal stations installed in the United States. After observing their operation the lighthouse service proposes, as means are available and needs are developed, to establish similar stations near important ports on the seaboard, on the Great Lakes, and on some of the principal capes and lightships.

This newest ally of the seafarer enables him to guide his ship or determine its location, although sea and sky may be blotted out by fog at the time. The method is not at all complex. One or more lighthouses or light vessels are equipped with apparatus for sending radio signals of simple and definite characteristics.

The radio compass on shipboard responds to these signals and indicates the direction from which they come.

The navigator locates his position by the process of triangulation or cross bearings and steams through the fog free from fear of shoals or reefs. He may get his position from the signals of a single station, either by taking repeated bearings and logging the distance travelled between bearings or by a single bearing and dead reckoning. The method of cross bearings is, naturally, more convenient and more accurate.

When the system is more widely developed, when all ships are equipped with the radio compass as well as the customary radio apparatus, the danger of collision between ships will be greatly lessened and the rescue of disabled craft will be greatly facilitated. Two incidents will illustrate this point.

The Norwegian steamer *Onataneda* was in distress in a fog off Newfoundland, and gave

The Lighthouses are Miniature Transmitting Stations. Signals from them are picked up by the square coil in the foreground when it is pointed in their direction. The coil is mounted above a magnetic compass which always points north. The direction taken by the square coil when signals are heard loudest indicates the bearing of the lighthouse. Where two such bearings cross is the position of the ship

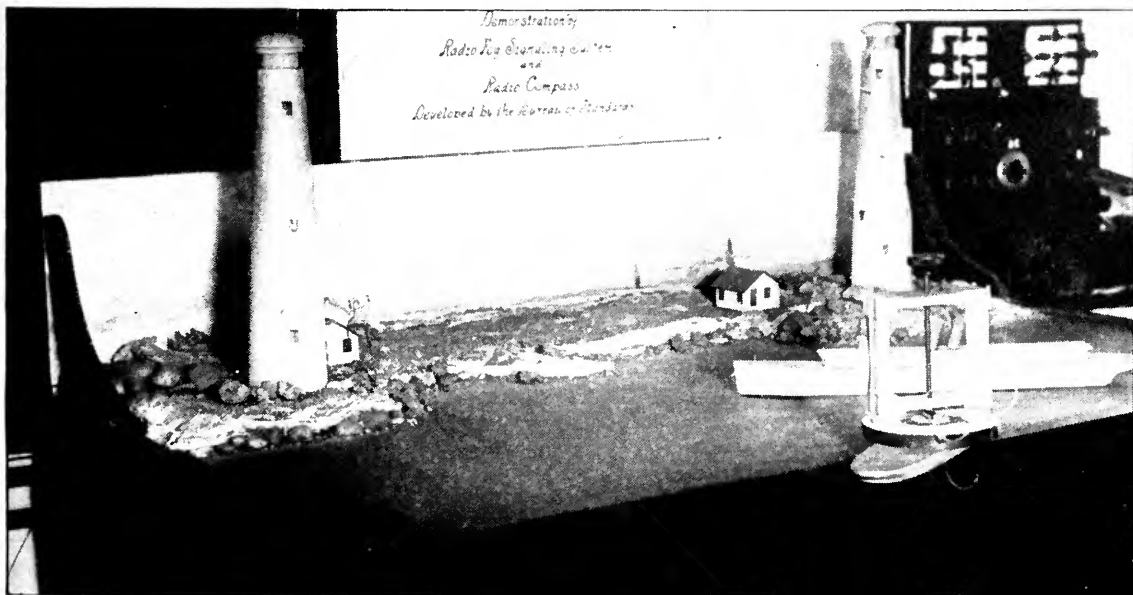

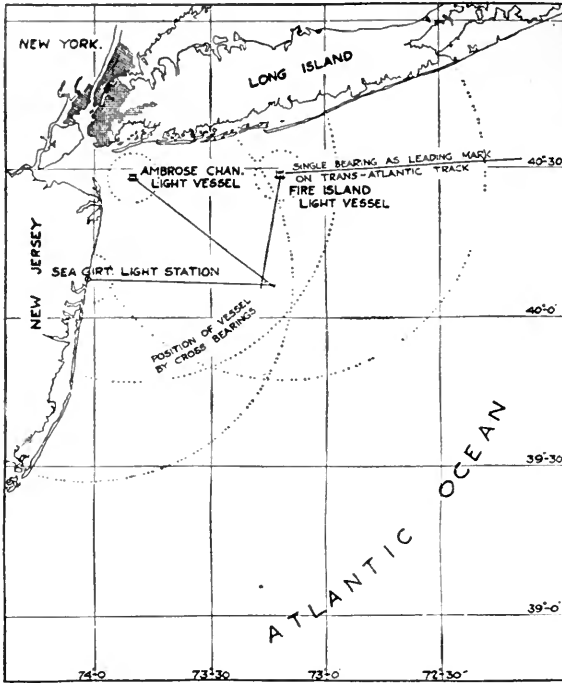

Chart, showing location of three radio fog signals in the vicinity of New York, with example illustrating the use of radio signal as leading mark for which a vessel may steer in approaching New York; also example of the obtaining of the position of a vessel by cross bearings on three radio stations. The distinctive characteristics of the signals from these three stations are indicated by dots on the circles; the larger circles are at the approximate useful limits of these signals

her position by dead reckoning ninety miles in error. The only ship able to discover her correct position and help her was the *Fanad Head*, equipped with a radio direction finder. The steamer *Wabkeena* was within fourteen miles of the steamer *Alaska*, lost off Cape Mendocino, Cal., when the latter was sending out distress signals. But the *Wabkeena* had no means of determining the direction of the signals and she steamed around in the fog for ten hours before she reached the scene of the wreck. Long before that time the *Alaska* had gone down.

The three stations established near the port of New York are the Ambrose Channel light ship, the Fire Island light ship, and the Sea Girt light station. A glance at the accompanying chart will show the reason for these designations; that is to say, they form a natural triangle.

Characteristic signals identify each station. Ambrose Channel sends one dash; Fire Island a group of two dashes; Sea Girt a group of

three dashes. The particular station is thereby as definitely located in a fog as a lighthouse in clear weather. The signals are operated continuously during foggy weather. To avoid interference the signals are sent on different time schedules, thus: Ambrose Channel sends for twenty seconds, silent twenty seconds; Fire Island sends 25 seconds, silent twenty-five seconds; Sea Girt sends sixty seconds, silent sixty seconds.

A special automatic, motor-driven timing switch produces the desired signal at regular intervals. A wave length of 1,000 metres is used and the range varies from thirty to one hundred miles, depending upon the sensitivity of the receiving apparatus.

The radio compass is a simple mechanism consisting of about ten turns of insulated copper wire upon a rotating wooden frame about four feet square. The frame or aerial is mounted on a spindle provided with a pointer. The aerial is usually mounted on the roof of the pilot house and the spindle terminates directly above the centre of a standard ship's binnacle. The pointer on the spindle, therefore, enables the navigator to read the direction of the fog signals directly upon the compass card.

The principle upon which the radio compass works, then, is this: When the plane of the coil on the pilot house is parallel to the direction from which the radio signal comes the signal reaches its maximum distinctness. As the coil is revolved the sound diminishes until it reaches a minimum, either side of the maximum point. Halving the difference between the two minimum points indicates the direction more accurately than the point of maximum intensity. As the coil rotates the pointer on the spindle accompanies it around the compass, so that the navigator can get the magnetic bearing of the radio signal station at a glance when the minimum point is reached.

During the war considerable use was made abroad of radio compass stations located on shore. After the war the Navy Department established similar stations on the coast of the United States and a number of these stations are now in active operation and furnishing bearings to ships asking for them. The system is the reverse of that adopted by the Bureau of Lighthouses, since the bureau system enables the navigator, if his ship is equipped with a radio compass, to take his own bearings.

The Audio Piloting Cable in the Ambrose Channel

By DONALD WILHELM

THERE are times when seamen yearn for a peep of the Ambrose lightship—times when fog hangs over them, the old man of the sea. There are times when, just short of New York Harbor, and hundreds of other harbors as well, they have to lay to and wait for hours or days.

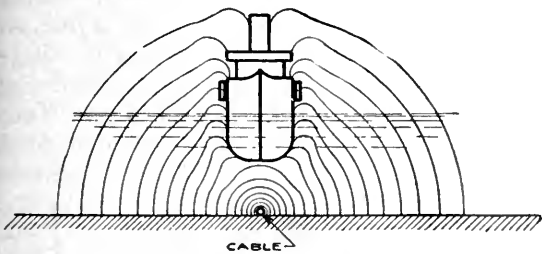

The manner in which a ship is guided by the "Audio Piloting Cable" is shown in this illustration. The collector coils on either side of the vessel are affected equally by the current in the cable when the vessel is directly above it. This results in the production of sounds of equal intensity in the telephones used by the pilot

It's depressing to passengers, to crews, to everyone on shipboard to be brought up short like that with their journey's end in view. And it's expensive—when a great liner has to wait on the weather the hourly maintenance cost per vessel ranges all the way from \$500 to \$4,000, the authoritative figures. But for \$50,000 initial cost, and as little as fifty cents an hour operating cost, an audio piloting cable has been laid and been operated through the Ambrose Channel, and can be laid at relative cost, and be operated through almost any channel in the world.

The Navy has demonstrated that. Figuring the cost of receiving equipment on each vessel at \$1,000, it has shown that the typical vessel might pay for its equipment with less than the cost of a few hours' delay off a typical port. And the cost of the cable itself, incidentally, is no more than any one of a number of individual buoys in and about New York or almost any large and typical harbor.

What's more, a blind man, properly equip-

ped, if he can but hear, can steer a ship accurately along such a cable.

The proof is in. Pilots, blindfolded, with only a bit of instruction, have publicly demonstrated just that. With only the first run of experimental coils, amplifiers, condensers, and switching devices, all of which the Navy is perfecting at the New York Navy Yard, novices, or old seafaring men new at the radio game, and other mere landlubbers, took the helm, and though blindfolded or with the bridge of the experimental ships closed in with canvas, followed the first major audio cable part or all the way from Fort Lafayette to hailing distance of the Ambrose Light or from the Light back the other way.

Clearly, such a device has a future in these days when some sailors have come to trust more and more to radio and when they have become accustomed, as many have, to the use

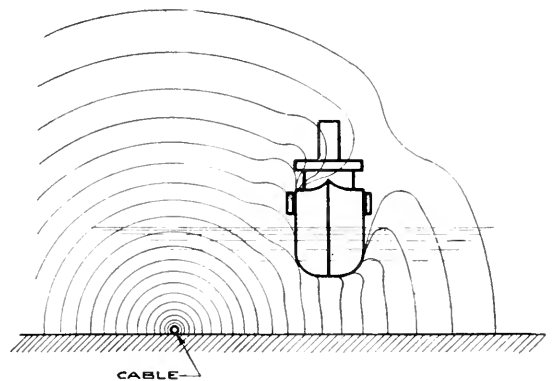

When a vessel leaves the direct path of the "Audio Piloting Cable" the collector coil nearest the cable is affected to a greater extent than the farther coil. This results in the production of unequal sounds in the pilot's telephones, and he then alters his course in the direction of the stronger signal until the strength of each is the same

of the radio compass to get them within automatic steering distance of the cable. Thus, it has been recommended to the Navy that the Ambrose audio cable be extended past the Light a mile or so, at which point it will divide and run northeasterly and southerly for five

miles or so. Then New York Harbor will lose its terrors even in the worst weather, to ships properly equipped with radio. It will, we can assume, be as safe for navigation during bad weather as the open sea. In other words, liners or other vessels properly equipped—and once the audio system is in vogue, legislation can be employed to make them carry equipment, exactly as legislation has required all vessels with more than fifty souls on board to carry distress wireless equipment—can race in toward the Lightship, pick up their bearings by radio compass, edge in and make contact with the audio cable, and make the harbor.

It was in October, 1919, when Commander Stanford C. Hooper, in charge of the radio division, Bureau of Engineering of the Navy, ordered A. Crossley, an expert radio aid, to proceed to New London and undertake the Navy's first major experiments with the audio cable, the promise of which has already been indicated by a long range of theoretical conclusions, along with the development of the equipment necessary, plus a few actual experiments, notably those of Expert Radio Aid R. H. Marriott, who made some experiments in Puget Sound and suggested their development to Commander Hooper.

At New London, first a wooden ship was used, a launch. And when it was discovered that there was no shielding effect from the launch's hull, it was found to be practicable to keep the launch within ten feet of the invisible cable, horizontally, and to steer it, of course, either way, to pick it up here or there and to use the device handily.

Then a metal ship, a submarine, was used, and the shielding effect of the metal hull was noted, on the action of the coils at either side

of the ship. The experiments conducted on the G-1 demonstrated that its commander could tell on which side of his vessel the cable lay. The strongest signal was always picked up by the coil nearest the cable while the minimum signal was received by the coil farther from the cable. And when the end of the cable was reached both signals eased off.

At once, then, the Navy proceeded to larger experiments in the Ambrose Channel. But

there was trouble when the longer cable laid there was tested out and investigation proved that the cable had parted, probably in the laying, at precisely fifty-two places! So the New York Navy Yard went at the business of developing and testing out a decidedly better cable, which, when duly laid and anchored, did all that was expected of it. For the *U. S. S.*



U. S. S. "ALGORMA"

Algorma, a large Navy sea-going tug, fitted with receiving equipment, steamed at her master's whim, almost exactly over the "audio."

The amplifier and switching device used on her were installed in the pilot house and the collector coils were rigged out from the opposite sides of the vessel on a level with the upper deck, about amidships, and about fifteen feet above the water-line. Steaming at right angles to the cable, she could pick up the signals 100 yards from it, and to follow it was like following a hand in the daylight. During the return trip to the city, in fact, the pilot house was blanked off with shutters so that the navigating officer could not see daylight yet he brought the *Algorma* through the Channel without aid of any sort, with the ship at no time more than fifty yards from the cable and most of the time squarely on top of it—this, though the navigating officer had received only three hours of training. And when the de-

stroyer, *Semmes*, was used later in public demonstrations, one of those who took charge, Captain Battle of the Cunard liner, *Virgilia*, though a total stranger to the system, by relying on a certain constant signal strength from the port coil, steered the *Semmes* along the twenty miles of the cable always within fifty yards of it, and always on the correct side of the channel.

The power used was supplied by commercial sources via Fort Lafayette. It was demonstrated that a current flow of three amperes was sufficient for all needs in water up to 200 feet. Other conclusions reached by the expert radio aid in charge, A. Crossley, pointed out that a collector coil having 800 turns of wire gave twice the audibility of the 400-turn coil; that the coils obviously must have identical electrical constants; that the use of tuned resonant receiving circuits increased the efficiency of the system 1,000 per cent., under which condition the cable can be picked up at

1,000 yards on either side of the cable, "which," he adds, "further increases the possibilities of the system for deep-water work." He remarks that very little difference was noted in the received signal strength when the coil was submerged or placed above the surface of the water, and that the use of the loudspeaker was found to be impracticable as the minute energy received from the cable at a distance will not actuate the diaphragm of a loudspeaker—only when the vessel was within forty yards of the cable would the loud speaker operate.

There are practicable refinements in the cable used and in the receiving equipment, which the Navy is developing.

And there is a future for the audio cable, the Navy officials are agreed. Its fullest usefulness at American ports and elsewhere waits, however, on that larger appreciation of radio devices for sea as well as air navigation which pilots, both on the sea and in the air, expect, but do not as yet demand.

Progress of Radio in Foreign Lands

WORD has been received that the three daily newspapers in Vancouver, British Columbia, have each installed high-power radio sending equipment, by means of which isolated camps and farms are being brought into touch with the happenings of the outside world. Statistics recently published in the United States show that, whereas six months ago there were less than 50,000 receiving outfits in the whole of the country, and 40,000 of these within 100 miles of New York, to-day there are at least 800,000 of them, and the demand continues to be so great that the factories cannot cope with it. There are well over 200 radio-telephone broadcasting stations now in operation in the United States, and we can be certain that our neighbor to the north is becoming quite as enthusiastic about radio telephony as we are. In a short time we shall be listening in to Canadian broadcasting stations along with our own home stations.

At a conference recently held in France by the airway managers and pilots in order to draw up rules to prevent a recurrence of such an air collision as that which took place over

Northern France on April 7th, among other resolutions the following were passed: That all commercial airplanes must be equipped with radio telephones; that additional ground radio and weather reporting stations should be established at Poix and Noailles on the French section of the London-Paris airway; that the terminal air stations of Croyden and Le Bourget should now be in constant communication with each other by radio telephone as well as by ordinary radio; that the question of interference with radio telephony by the powerful Eiffel Tower radio station should now be investigated; that the ground radio station at St. Inglevert, on the French coast, which was destroyed by fire recently should now be replaced.

RADIO ON FISHING BOATS

ACCORDING to an article in a recent Bulletin of the Oceanographical Society of France, it appears that despite the interruption due to the war, considerable progress has evidently been made in the extension of radio communication to the French fishing fleet. In the space of ten years radio apparatus has been installed on some 200 vessels. In order

to have the messages from the fishing vessels transmitted as rapidly as possible, the French postal authorities, who are in control of communication systems in France, have them telephoned direct from the coast radio stations to the owners. La Rochelle is the only fishing port of importance which is not yet provided with a radio station, although some forty trawlers of that port are equipped with radio. At St. Pierre and Miquelon there is not as yet a sufficiently powerful coast station, but an up-to-date equipment with a radius of 600 miles is expected to be installed during the next season.

WHAT IS A RADIO OPERATOR?

FROM the London *Electrician* we learn of a dispute that has arisen between the Association of Wireless and Cable Telegraphists which has a membership of between 5,000 and 6,000 (95 per cent. of the total of British wireless operators), and the London District Association of Engineering Employers, representing the shipowners and the wireless companies. The men's secretary states that, in addition to a reduction of wages, the telegraphists were to be called upon to perform "other duties" besides telegraphic work. They had attempted to get a definition and a conference, but only a vague reply was given which would leave them entirely at the mercy of the shipowners and the captains. The question of wages alone could no doubt be satisfactorily settled. The men had been instructed to refuse to sign on any ships, and already 300 to 400 men were out. No doubt by the time this is read the trouble will be over, but the fact remains that a radio operator is often called upon to do work quite foreign to his duties as a radio operator. So the question: What is a radio operator?

THE INTERNATIONAL LOUD-SPEAKER

WHEN our loud-speaker enables us to hear radiophone broadcasting stations several hundred miles distant, we believe we are doing very nicely, do we not? Well, in Europe they are doing still better, and taking it more or less as a matter of course. While we have made remarkable progress in the transmitting end and in the introduction and working out of the radiophone broadcasting idea, it appears that the Europeans know a little more about radio-frequency amplification than we do—at least they make more use of it than we

do. For instance, it is reported that a loud-speaking radio telephone receiving set has just been completed at Lausanne, in Switzerland, which gives the radiophone concert sent out by the Eiffel Tower in Paris, a good 500 miles distant, as well as the stations in London and Berlin. The high-power radio telegraph stations of the United States are also being picked up by this receiving set and made audible throughout a large room.

EXPEDITING PORT BUSINESS WITH RADIO

THE radio telegraph stations which have been installed in the port office of the French inland city of Rouen and on certain pilot boats by the Rouen Chamber of Commerce have been officially put into service. These installations will be used exclusively for transmitting messages relative to maritime affairs, promotion of the port, and services for and of the port. The pilot boats equipped with radio will keep the port office informed of the arrival of vessels coming up the Seine River on every tide and will be instructed by the port office in regard thereto. Merchant vessels not equipped with radio and having urgent dispatches to transmit to local ship brokers before docking can do so through the port office, via the pilot boats. Other radio messages or dispatches not relating to navigation or the port of Rouen and its services must be sent through the public radio station at Bleville.

MAKING THE TELEPHONE RECEIVER MORE SENSITIVE

NO LESSER authority than G. Seibt of Germany has found it possible to increase the sound intensity of a telephone receiver by laminating or subdividing the pole pieces above the poles of the permanent magnet and by introducing a magnetic shunt or by-pass for the magnetic flux, just below the coils, according to *Elektrotechnische Zeitschrift*. The pole-piece divisions or laminations are made of 4 per cent. silicon steel. The magnetic shunt air gap was found to be most effective when set to about 2 millimeters. The diaphragm is made of the same steel as the pole-piece laminations instead of the previously used American ferrotype steel. Tests made with such receivers showed an increase of sound intensity of from two to two and four-tenths times that of the old model. The new receiver is already being made on a large scale.

IN RADIO, at least, Great Britain has much to learn from us, even if we are a much younger country. Until the present the British radio amateur has been operating under the most adverse and discouraging circumstances, and if his numbers have increased despite all the obstacles placed in his path, it is due to the attraction which radio holds for so many of us. The problem of licenses in Great Britain has become very acute. Just so long as the amateur was satisfied to receive and perhaps to send with extremely limited power, there was no objection to his activities. But now that the amateur is getting more ambitious, the problem is getting serious. Another thing is the lack of public broadcasting in Great Britain. The British amateur, as well as the clockmaker, receives his time signals from Paris, Moscow, and other centers—second-hand Greenwich time, to be sure; but since his country does not broadcast its own official time, he must get it from abroad. The British ether is filled with dots and dashes, but practically no radiophone broadcasting. The amateurs are now clamoring for a central broadcasting station like those operating in the Hague and in Paris, and it appears that their demands will be granted in the very near future.

GREAT BRITAIN'S WORLD-WIDE RADIO PLANS

THE publication of the report of the commission appointed to study the problem of world-wide radio communication for the British Empire discloses a number of interesting facts bearing on present-day radio. To begin with, the commission suggests that the communication should be effected in steps of about 2,000 miles, which is considerably less than the more ambitious jumps of a few years ago. Then the suggestion is made that vacuum tubes be employed to generate the radio energy used in transmitting. The excellent results obtained with a set of 48 vacuum tube oscillators used in the Carnarvon station with an input of 100 kilowatts, which was pushed up to 150 during the trial, are referred to. Messages were successfully transmitted to the United States, India, and Australia with this arrangement. It is stated that valve or tube renewals will be from 50 to 60 per cent heavier if alternating current is used instead of direct current, presumably due to the use of thermionic rectifiers. With regard to wavelength, it has been found by actual tests between Horsea and Egypt that

the best results over this distance can be obtained by the use of relatively short waves during the night and of a long wavelength during the day time. It is recommended that the masts be of steel, 800 feet high, insulated not only at the base but at intermediate points. Counterpoises are recommended instead of ground connections. With regard to duplex working, it is recommended that each receiving station should have a separate antenna and receiving apparatus for each distant station with which it may have to communicate, so as to allow of simultaneous reception from all. As a temporary expedient, it is suggested that

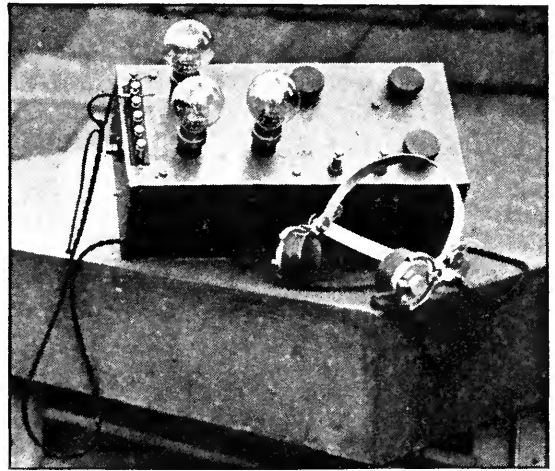

©Wide World Photos

The English Marconi Company has produced this broadcast receiver for home use. It may be installed and operated by the layman

arc generators be used. However, these are to be replaced as soon as possible with tube oscillators. It is interesting to note that no reference is made to high-frequency alternators.

FRENCH GOVERNMENT COMMUNICATION PERIODICAL

AMERICAN radio men will find much of interest in a French Government periodical called *Annales des Postes, Telegraphes, et Telephones*. This periodical is issued bi-monthly by the French Ministry of Posts and Telegraphs and each issue usually contains from 100 to 200 pages. It has been published for the last ten years. Telegraphy, telephony, radio communications, and the machines used in post offices are included in its field. In wire telegraphy, automatic high-speed systems, as

well as older systems, are covered. Communication by submarine cable also receives attention. In telephony, attention is given to the ordinary systems, and to automatic systems, repeating devices, traffic and operating problems, and the use of radio-frequency currents. In radio communication, attention is given to the principles, construction, and operation of a wide variety of devices and methods for transmission and reception. Results of researches conducted by the Ministry of Posts and Telegraphs are published in this periodical. Notices and abstracts are published of articles pertinent to the field of the *Annales* which appear in other French periodicals, and in foreign periodicals. The editorial staff of the *Annales* includes a number of prominent engineers, including Messrs. Denery, Blondel, Ferrie, Milon, Abraham, and Gutton. The annual subscription price is 27 francs, and orders may be addressed to the *Annales* at 3 Rue Thénard, Paris, France.

RADIOPHONE BROADCASTING IN PARIS

NOT slow to appreciate what broadcasting has meant to the American public, the French have gone in for the same thing. Just now the broadcasting centre of France is the Eiffel Tower station, operated by the French Army Signal Corps. The station has a radiophone range of 1500 miles and is transmitting radiophone programmes on a regular programme basis. In connection with their broadcasting activities, it appears that the French Army Signal Corps have been experimenting with the radio link idea—the insertion of a radio telephone section in regular telephonic communication. It is believed that at an early date it will be possible for a subscriber in Paris to speak, via his own telephone instrument, to a friend in London, using his own telephone instrument, the Eiffel Tower station being used for one end of the radio link. But for the time being the radiophone broadcasting is of prime importance and is pleasing the French public quite as much as our broadcasting activities have pleased us. It is also reported that the airplanes traveling over France and to England

pick up the radiophone concerts and enjoy them, high in the air.

A UNIVERSAL RADIO SIGN LANGUAGE

FROM various sources these days we hear requests to the effect that all radio diagrams be made in a uniform style. Since diagrams, as a rule, require no explanatory text, it is evident that they are one and the same for all languages. They are a universal language, to be sure. But due to the use of many different styles of symbols to mean one and the same thing, much confusion is encountered in using radio diagrams. It is now proposed that all diagrams be made with the same kind of symbols, which could be standardized with little trouble. In Germany the radio symbols have been practically standardized, so that all radio diagrams are more or less of the same general appearance.

THAT GERMAN INVASION

FROM time to time someone starts a rumor going the rounds of the radio fraternity, to the effect that Germany is soon to invade this country and flood it with wonderful radio apparatus. We have heard such rumors, one and all of us. We have heard of the remarkable vacuum tubes that are to be sold so cheaply that they will be virtually given away. We have heard of the remarkable receiving sets, costing so little that it will no longer pay to bother making a set, and so on without end. However, several months have gone by, and the German flood or invasion, whichever you wish to call it, has not materialized. And it is our firm belief that it is not likely to materialize in the near future. The patent situation, with regard to many features of radio equipment, is such that German products, many of which are not licensed or patented in this country, are not likely to find their way to our markets because of the danger of their being infringements of American patents and engendering expensive lawsuits. Especially is this true so far as tubes are concerned. All in all, the American radio industry has little to fear from German competition for a long time to come.

Radio Helping Us Enjoy the Summer

Our Vacations may be Better Spent if Radio is Taken with Us. In this Article Various Means are Suggested for Eliminating the Difficulty of Erecting the Summertime Antenna

By ARTHUR H. LYNCH

SUCH rapid strides have been made and so much good has come of boys and young men operating amateur wireless stations, that the U. S. Government has gone so far as to encourage its use, and Uncle Sam has not been satisfied merely to say, "That's a very instructive and helpful hobby you have taken up, my boy, keep at it and it will do you a lot of good." No, indeed; he has done much more than simply express his pleasure and give some verbal encouragement. He has actually instructed various government wireless stations to give the amateur a helping hand. And who is in a better position to help in that regard than our benevolent uncle?

For some time past, there have been men in the employ of the Government, who, either for selfish reasons or because they did not have vision enough to see that one day wireless would be of vast importance to our country, have endeavored to introduce and put into effect laws which would materially reduce the scope of amateur radio endeavor, if not prohibit it entirely. Such narrowness is to be regretted, and we must feel grateful to those who have overcome such attempts at legislation and have brought about a condition in which the amateur radio worker is not only encouraged but materially aided. Perhaps it will be of value to consider some of the reasons which would make such laws harmful not only to the worker himself but to the entire nation and possibly the world. It sometimes takes a war, or kindred upheaval, to make some men realize the value of things which seem useless or even an impediment to progress, and that is precisely the case with amateur radio.

But a few short years ago there was a flood in this country and the railroads were put out of business in the section which was flooded. The telegraph lines were also torn down, as were the telephone lines. The people within the stricken region would have been without communication with the rest of the country had it not been for the amateur wire-

less operators, who took it upon themselves to establish a reliable communication service and thus let the rest of the country know the needs of those who were suffering.

That was before the Government had taken such active part in the promotion of amateur wireless affairs, and there were many other similar instances of like importance which went to prove that the hobby was valuable, not only to the boy who enjoyed it himself, but to his fellows. It is interesting to observe a few things which have gone on since that time and see what effect they have had upon the country at large.

One of the most striking examples of the value of radio to the country is seen in the Great War. There are but few who will even attempt to claim that this country was in



This is an ex-service, man-carrying kite now used to carry an antenna. Some idea of its size may be had by comparing it to the men who are holding it. A suitable kite-string may be made from a stout clothes line

a state of preparedness, even though we should have learned a lesson about preparedness from our Mexican Border experience when the supplies for the National Guard were so insufficient as to hold up the movement of our troops in nearly every state of the Union for long periods. Even at the end of the Border Expedition, we could hardly claim to be prepared for any great emergency. But we went into the war with Germany unprepared, and the result of our unpreparedness is reflected in our having resorted to the floating of five loans, amounting to many billions of dollars, for the production of military supplies, to say nothing of food and ships. Unfortunately the ships, at least a very considerable part of them, were built at too great a cost and in a manner which would prevent them from being kept in service for any considerable period, and to-day the waste resulting from our unpreparedness may be indicated by the fleets of war time ships which have been lashed together and placed in harbors from which they will never again sail. They are a total loss, except for the purpose they served, which, though it was important was also extremely costly and would not have been necessary if we had been prepared.

And then there was the matter of training many thousands of men to take up various forms of military duty, and it is here that we may pause a moment and consider again how amateurs were able to help the Government. In any form of military training a certain amount of time must be spent in learning the ways of the army and the navy and the air forces in war time. There were but very few of our military units which could be filled by ordinary citizens and there were but few of our citizens capable of stepping into the stride of military affairs by reason of their experience in civilian life. In some instances, especially the professional branches of the service, which were capable of carrying on their work with little or no military training, we see just the opposite, for instance the Medical Corps, composed as it was of doctors and druggists and nurses, who did not have to be put through a long course of training before they were in a position to do good work. And this is exactly the case with radio.

Radio, in the war, was as necessary to our winning; it as were our battleships, our troop ships, our guns or our men, for the reason that without its aid our army and navy would not have been able to keep such accurate check on

the workings of the enemy, and would not have been able to have military or naval maneuvers regulated with the precision which was found to be so necessary. But that is a long story, and we will not discuss it more. The point in mind is this; when the war broke out there were nearly 5,000 amateur radio operators in this country, who with little or no instruction were capable of entering upon a military career which was of great value and importance to the nation. Those fellows who had learned to send and receive rapidly, to build their own apparatus, to take reasonably good care of storage batteries, and especially those who had done any work with the latest forms of apparatus could step right into the breach and prove their worth by doing in a very short time what it would have taken them months to learn if they had not been allowed to carry on their pet hobby in times of peace.

There are instances without number which would go to prove these statements, but as interesting as they are, we can not consider everything at the same time, and they may furnish the fruit for interesting discussion later on. But we must say in passing that such instances as have been mentioned have gone far to establish a place in Uncle Sam's heart for the amateur radio fan and have helped to bring about some of these very encouraging conditions.

It is needless to mention that Uncle Sam has endorsed the activities of the Boy Scouts in this country and that he wants to do everything in his power to assist them. One of the greatest subjects in the Scout's course of study is signalling, and we must pause for a moment to consider it and how much Uncle Sam thinks of it—more, perhaps, than any other branch of Scoutwork. And there are many boys throughout the country who do not know how far our good uncle is going in his effort to help them to help themselves and help him, if he again needs their help, in this matter of signalling.

A FEW OF THE MORE IMPORTANT AIDS

FOR many years the U. S. Naval Radio Station at Arlington has sent out time signals and weather reports for the guidance of mariners, and this is also true of many of the other naval and other government stations throughout this country and its dominions. The value of these signals is very great, as it is through them that it is possible to keep ships' chronometers—which in plain American,



When the kite is near the ground it sometimes behaves badly and requires considerable attention, but once it has reached a height of 300 ft. or more, little difficulty is experienced with it.

merely means "clocks"—checked up and thereby navigate with more certainty. The weather reports are of similar importance and need no further mention. These signals, sent as they are on regular schedules, give the student of radio an opportunity to practice adjusting his apparatus as well as practice in receiving by the International, or as it is better known, the Continental Code. In addition to this time and weather reporting service, there are many stations throughout the country which send the news of the day to all stations which may desire to copy it, and the amateurs may well avail themselves of this opportunity.

In addition to these signals and those of the regular commercial and amateur stations, Uncle Sam has decided that every opportunity will be given the amateur to become proficient in receiving the code and has accordingly instructed certain of his naval and other stations to transmit certain amateur information upon well-regulated schedules and at a slow speed, so that the beginner will have an opportunity

to progress to a point where he will be able to receive the regular press and commercial messages without difficulty. The general plan followed is to have several of the stations, generally Navy stations, send out these amateur broadcasts each evening at a scheduled time. Where there are radio clubs, the value of these broadcasts is increased because the fellows can get together and compare the results of their receiving and locate their errors.

Another and just as important step has been taken by the Bureau of Markets, of the Department of Agriculture. In order to keep the farmers advised of market conditions as well as the weather, this department has undertaken to establish a *wireless telephone* service, which embodies several stations which send out the above information on certain schedules in such a way as to enable them to be received over distances of approximately two hundred miles without requiring any particular skill on the part of the operator.

All that is needed to secure the information which is thus sent out is a simple receiving set, such as may be found in many amateur stations. The value to the boys and the farmers of this information is very great. In towns where this information has not previously been received with regularity, it will be possible for the boys to rig up an outfit and invite their

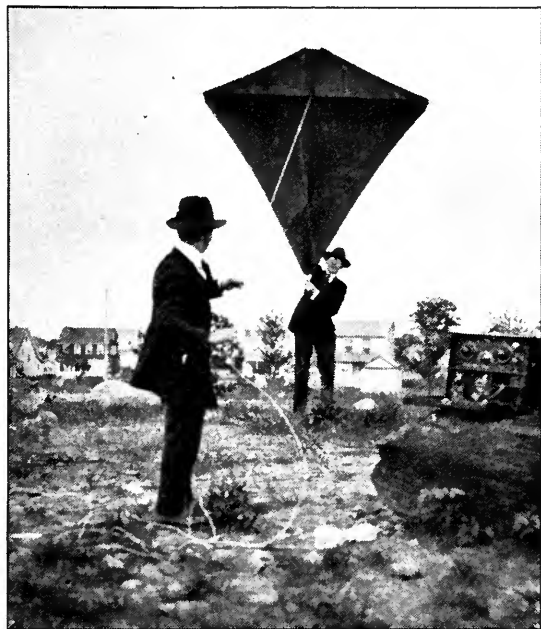

Ashore, the kite-supported antenna materially increases the distance over which radio broadcasting may be received. The kite in this illustration is 7 ft. high

friends in to hear a representative of the U. S. Government *talking* to them over the wireless telephone. They will not even have to know the code. The value of the information may not be understood by the boys themselves for a time, but go and get the president of the chamber of commerce in your town and tell him that you can supply him with information about the weather and food market conditions, received right from Washington and you won't have to do any more worrying about where the money is coming from to buy new wireless apparatus. The information will be worth enough to the community for it to buy your apparatus for you. If you don't think so, take this with you and ask your local Chamber of Commerce or Board of Trade what they think of the plan. So that is what Uncle Sam is doing, and from now on we will consider the least expensive method for obtaining satisfactory results in availing ourselves of these very great aids to the study of wireless telegraphy.

OVERCOMING SOME OF THE DIFFICULTIES

ONE of the greatest difficulties in connection with a wireless station, especially where it is not to be a permanent installation, is the arranging of the overhead wires, generally known as "aerial" or "antenna." Now, for use in connection with communication in stations which are to be permanent, it is very desirable to refer to some good authority on such matters and not go into the thing in a haphazard fashion.*

But, where there is no possibility of planning the station beforehand, which is generally the case when it is desired to communicate between two Troops of Boy Scouts in different parts of some woods, it is necessary to do whatever is possible and more or less trust to luck. For this reason we will consider two methods which have been tried with very great success, especially with portable sets.

Of great importance is the erection of the aerial, so we will now consider it. The most suitable aerial for amateur portable field sets is, the single wire; that is, merely one wire in the air. There must also be a ground connection, but that is readily taken care of by driving a metal rod three or four feet into the ground or, better still, dropping it into water and attaching a wire to it, so we will confine ourselves to the aerial. On camping trips, it is generally advisable to be provided with plenty of copper

wire for the making of several aerials, and it is also advisable to have several well-designed kites along, to be used as described later on. The first and most simple aerial is made in a few minutes and requires but one boy to get it in the air. If the troop is supplied with some stout twine and a few porcelain insulators, which may be had for a few cents, it is merely necessary to attach one insulator to the end of the string and then cast it, sling-fashion, over the top of any tree suitable for the purpose. When the insulator reaches the ground, on the opposite side of the tree, it is merely necessary to fasten a wire to it and pull in enough of the twine to raise the wire to a position about fifteen feet from the branches of the tree. The twine may then be fastened, and the wire may then be used for an aerial.

Another very satisfactory method for raising an aerial is to fly a kite or several kites and run a wire up on the string. By using a suitable kite, such as the one described, it is possible to substitute copper wire for the kite string and fly the kite directly on wire, as is shown in the accompanying photographs. The kite string (wire) should be brought to an insulator before being connected to the set and the insulator should be fastened to the ground by means of a piece of cord or another piece of wire.

MAKING THE KITE

DURING the writer's boyhood, he was fortunate enough to have made the acquaintance of a man who was an expert on kites and kite flying, and a few tips upon the selection of the proper sort of kite for use in conjunction with a radio set as well as further tips concerning the making of such a kite from the figures of the kite expert himself will prove helpful. The kite shown in the illustrations was made according to the directions here given and proved entirely satisfactory.

It is best to be sure that the wood used for the ticks is spruce. That both the upright and cross sticks are of the same length. That the cross stick crosses the upright stick at a point one-seventh the distance from top to bottom. That no nails be driven through or into either stick. That the proper method of holding the sticks in place is to wrap them securely together, so that they may be readily taken apart again and folded up for carrying purposes. That the vertical or upright stick be placed so as not to bend, but with its flat side at right angles to the kite cover. That

*See page 214, also RADIO BROADCAST for May and June.

several sets of sticks should be provided for each cover so that it may be used for flying in different winds, the light sticks being used for the light wind and the heavier sticks for heavier winds. That the cross stick, in order to have the kite fly without a tail, must be bowed, and that the amount of bowing should be measured from the bowstring to the point where the sticks cross and should be equal to one-seventh the length of the stick. That the bowing on each side of the centre should be equal. This may be readily deter-



With a portable radio outfit and a kite these two radio enthusiasts are about to step into their canoe from the pier of the Bayside Yacht Club

mined by bowing the stick, placing it upon a flat board and following along the inside of the stick with a pencil, then reversing the position of it with the lead pencil mark; wherever there is a variation it may be corrected by carefully sandpapering the stick until the desired result is obtained. This is very important.



In the canoe the antenna is held in place by two small insulators and the kite is somewhere above. The "ground" connection is made by merely dropping a brass rod attached to the ground wire over the side of the canoe

and it is also a

good idea to use similar rings on each end of a piece of picture wire to form the desired bowstring, which, by the way, is always at the rear of the kite. It is not advisable to use paper for the kite covering because it will tear too readily and will not withstand water for very long. A

good, strong, light, and in every way suitable cover may be made from percaline, and if you are not very handy with the sewing machine it will be a good idea to get some female member of your family to make the cover for you.

The bridle should be attached to the front of the kite with a single piece of cord extending from the bottom of the upright stick to the point where the two sticks cross and this string should be just long enough to extend to either tip of the kite. The kite string should be attached to

the bridle at a point found by bringing the bridle to the tip of the kite, for ordinary flying. If it is desired to make the kite fly on a greater angle, that is "higher," it may be done by moving the kite string further up the bridle. In

most cases this has been found to be bad practice because the kite does not fly steadily but rises to a high point and then falls back.

Several kites, constructed along these lines, may be taken apart and packed in a small space and weigh very little, so it will be seen that they form a very satisfactory means for

making the aerial, where there are no trees available, such as is the case in the canoe, shown in one of the illustrations.

From these few facts about making kites very satisfactory results may be secured without much difficulty and for all around purposes

where a single kite is to be used the two sticks should measure five feet and their thickness depends upon the condition of the wind, though they never should measure less than one-half by nine-sixteenths inches. Where smaller kites are used it is advisable to fly two or more on the same string which they will carry without much sag. Box kites may be used, but it should be remembered that they do not fly on a very great angle and they require considerably more wind than the kites described. It should be further remembered that kites do not always behave as we would have them do, and it is not safe to fly them with wire for a kite string where they will be at all likely to drop over high tension wires and possibly cause trouble. It is well to be some distance from trolley or other exposed carriers of heavy current. If you use a kite in a canoe, as shown in the photos, be sure that there are a couple of paddles aboard, because the kite may pull you some distance unless you drop an anchor.

INTERCOMMUNICATION

Where two stations are equipped with the same kind of sets, it is a good idea to use the same length of antennae or aeriels, and in order to prevent confliction with the law, which requires that amateurs work on a wavelength not to exceed 200 meters, it should be remembered that a single wire 100 feet long will have a wavelength of approximately 150 meters; 200 feet will produce a wave of 270 meters and 300 feet, 375 meters. As kites do not fly very well upon such short strings, it is a good idea to fly the kite on string till it reaches a height of several

hundred feet and then tie the end of the string to the end of the wire.

There are so many varying conditions which govern the amount of money a fellow may spend and the best type of set he can get for his particular purpose for that amount, that it is quite impossible to attempt a description of the most suitable radio equipment, here. If you are in doubt, go to your radio dealer, and if there is none in your town it will be well for you to write to some responsible manufacturer, who will be pleased to direct you in the matter of your purchase. Do not be afraid that he will rob you, because he is as anxious to satisfy you as you are to be satisfied; that is good business.

Once you become interested in radio you will find it very entertaining, especially if you are near some of the large cities, where manufacturers of radio telephone apparatus send out wireless telephone concerts. With a set, such as illustrated here it would be possible to receive music from such a station many miles distant, and by amplifying the received music it would be possible to have the entire summer colony hear the concert. By cooperating with the editor of a country newspaper it would be possible to issue daily the market reports previously described and last, to the author the use which appears of the greatest value is in connection with your Scout activities. Troops may well be several miles apart and communicate with each other by erecting radio stations which may be carried by a single Scout, or strapped to the baggage carrier of a motorcycle or bike, which may be set working within less time than it takes to tell it.

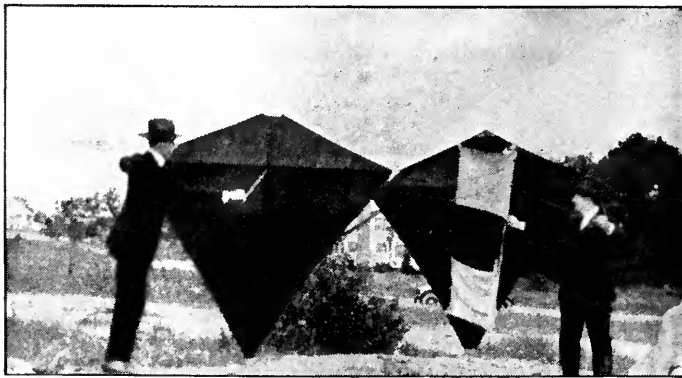

Here are two types of kites employed by the author in experimenting with the portable receiver. For all around use the left hand one is more suitable, but the right hand kite is better for an extremely high wind

Radio panels and Radio Parts

START right. The panel is the very foundation of your set. High volume and surface resistance are essential factors. Make sure that you get them in both the panels and parts that you purchase. To make doubly certain look for the dealer displaying this sign

^{CONDENSITE} **CELORON** Radio Panel Service

Condensite Celoron Grade 10—approved by the Navy Department Bureau of Engineering—is a strong, handsome, waterproof material, high in resistivity and dielectric strength. It machines easily, engraves without feathering and is particularly desirable for panels. It is also widely used for making many other important radio parts such as tube bases, platform mountings, variable condenser ends, tubes for coil winding, bases, dials, knobs, bushings, etc. We are prepared to make these various parts to your own specifications.

Where economy is a factor we can supply panels of Vulcanized Fibre Veneer made of hard grey fibre veneered, both sides with a waterproof, phenolic condensation product. This material has a hard, smooth, jet black surface, machines and engraves readily and will give excellent service where very high voltages at radio frequencies are not involved.

Shielded plates (patent applied for) are made with a concealed wire shield. This shield, when properly grounded, effectively neutralizes all howl and detuning effects caused by body capacities.

Send to-day for our Radio Panel Guide

Are you an enthusiast? This Guide describes our panels in detail—gives tests—and tells just how much the panel you want will cost.

Are you a Radio Dealer? Let us tell you how easily and profitably Celoron Radio Panel Service enables you to supply your customers with panels machined and engraved to their specifications. Write to-day for our Dealer's Proposition covering panels, dials, knobs and tubes.



Diamond State Fibre Company

Bridgeport (near Philadelphia) Pa.

BRANCH FACTORY AND WAREHOUSE, CHICAGO

Offices in principal cities

In Canada: Diamond State Fibre Co. of Canada, Ltd., Toronto.

Radio in Remote Regions

This department is devoted to stories of the use and benefits of radio communication in regions devoid of telephone and telegraph wires, and which are not reached by cable. Radio is proving a great boon, not only to explorers in the Arctic, the Tropics, and other distant places of the earth, but to mariners and lighthouse tenders on solitary islands, to distant army and trading posts, to hunters in the woods and ships at sea, to station agents at lonely junctions, and even to farmers dwelling in the midst of our country but separated by many days or hours from the news of the rest of mankind. RADIO BROADCAST will welcome any and all incidents which illustrate the value of radio in remote regions, and pay for those accepted at its regular rates.—THE EDITORS.

First Ship to Reach Island in a Year Gave Inhabitants News Three Minutes Old

IT WAS early in the summer of 1921 that the U.S.S. *Hannibal*, doing survey duty in and around Mosquito Cays, Nicaragua, Central America, steamed into the port of Georgetown, Grand Cayman, in the British West Indies south of Cuba. This was the first ship that had entered the harbor in a year, and, says Radioman W. D. Ross, U. S. N. "they sure were glad to see us."

This gladness changed to something akin

received at sea, and presented it to them when we reached port again."

The enthusiasm of the inhabitants of Georgetown, Grand Cayman, can be understood when it is realized that this little island, twenty miles long by five wide, has absolutely no means of communication with the outside world. No telephone, cable, or wireless connects it even to near-by Cuba. There is a small local telephone there, running from the Commissioner's

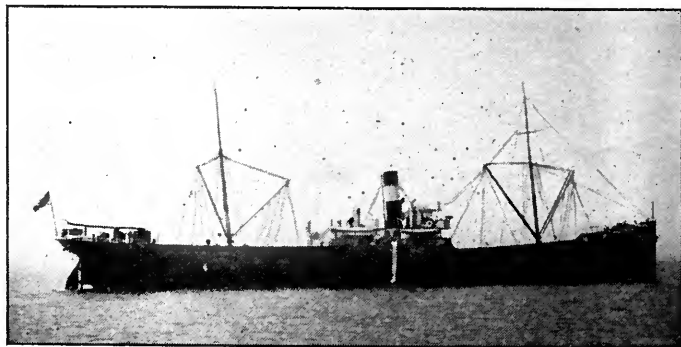

U. S. S. "HANNIBAL"

to rapture when they discovered that Ross could and would put them into almost instantaneous touch with the news of the outside world. Even stale news was more than welcome.

"They enjoyed the press that I gave them that was months old," says Ross, "and made special trips to the ship to get it. During the Dempsey-Carpentier fight we received the results three minutes after the knockout, picking up the high power station at Marion, Mass., which was sending to London. They were well pleased with the news. We always kept additional copies of our daily radio press

office to the post-office, a distance of one mile, but Radioman Ross was informed that his radiograms to the United States interrupted local telephone conversation. The mile of wire must have acted as a sort of antenna.

It takes months for a letter from the United States or England to reach this island. From the former it leaves Key West for Havana, Cuba, whence it proceeds to the Isle of Pines. Then it must go by steamer to Kingston, Jamaica, and from there by schooner to Georgetown, Grand Cayman. "And schooners," says Radioman Ross, "are scarce."

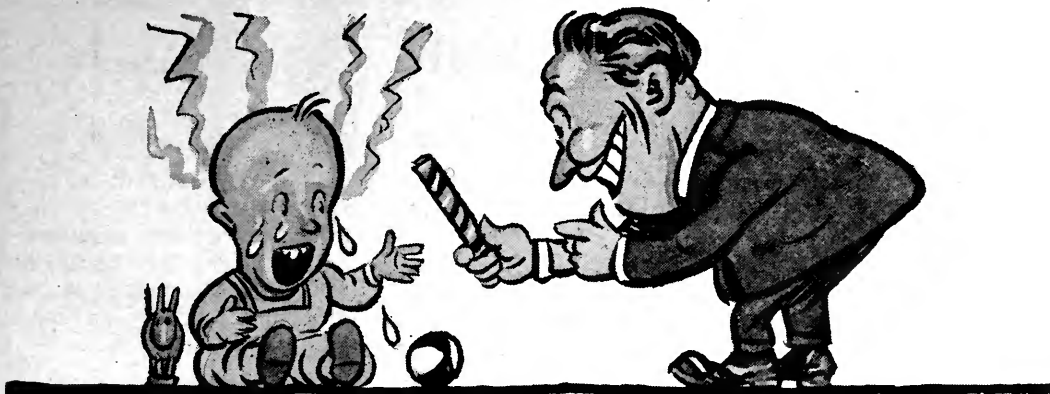

The end of a perfect howl—

THE squalls of a two year old are as music to the ear beside the howling demonstration put up by a fractious radio set. And how a set can howl unless one offers the soothing influence of the proper amplifying transformer.

Most any transformer can amplify sound, but it will also amplify the stray fields which produce howling and distortion. It takes the Acme Amplifying Transformer with its specially constructed iron core and coil to put an end to the howls and yowls. Only when you add the Acme do you get the realistic tone and volume so markedly absent in the ordinary radio receiving set.

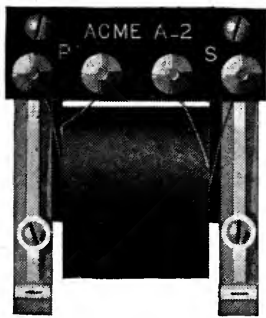

Type A-2 Acme Amplifying Transformer

Price \$5 (East of Rocky Mts.)

The Acme Radio Frequency Transformer greatly increases the range of any receiving set, either vacuum tube or crystal detector type. The Acme Audio Frequency Transformer produces not only volume, but reality of tone. It is indispensable to the satisfactory operation of loud speaking devices. The combination of one or more stages of Acme Radio and Audio Frequency Transformers assures the maximum of range, of volume and of reality in tone.

The Acme Apparatus Company, pioneer radio engineers and manufacturers have perfected not only Radio and Audio Frequency Transformers as well as other receiver units and sets, but are recognized as the foremost manufacturers of Transmitting Apparatus for amateur purposes. Sold only at the best radio stores. The Acme Apparatus Company, Cambridge, Mass., U. S. A., New York Sales Office, 1270 Broadway.

ACME

for amplification

The Grid

QUESTIONS AND ANSWERS

The Grid is a Question and Answer Department maintained especially for the radio amateurs. Full answers will be given wherever possible. In answering questions, those of a like nature will be grouped together and answered by one article. Every effort will be made to keep the answers simple and direct, yet fully self-explanatory. Questions should be addressed to Editor, "The Grid," Radio Broadcast, Garden City, N. Y. The letter containing the questions should have the full name and address of the writer and also his station call letter, if he has one. Names, however, will not be published. The questions and answers appearing in this issue are chosen from among many asked the editor in other capacities.

Care of Vacuum Tubes—Use of Rheostat

My vacuum tube lasted only two weeks. Can you tell me the reason for this?

Will a rheostat improve the action of an audion?

I wish to make a rheostat to use in the filament circuit of my detector tube. What resistance should I use?

How can I make a rheostat for my audion?

A VACUUM tube is a delicate piece of apparatus and must be handled with proper care. The designers have carefully planned the size, shape, and relative positions of its three elements (filament, grid, and plate) and have provided, in most cases, the strongest possible supports for these elements. However these supports are necessarily frail and the tube must not be roughly handled because one or more of the elements will break away from its support and thus the tube will be made useless.

Sometimes jarring a tube will simply loosen an element from its support and the tube will apparently be in perfect condition. Such a tube when used in a receiving set will cause it to "howl" whenever the set is subject to the slightest vibration, such as that caused by a person walking in the room, or a truck or trolley passing in the street. The howling is caused by the to and fro movement of the loose element, which, in turn, causes a variation in the current passing through the tube. This variation of current produces a noise in the telephone receivers which drowns out the desired signals.

As the name implies, the air has been exhausted from the inside of the vacuum tube. Extra special precautions have been taken to get a high vacuum—that is, to get out all the air. The tube is then sealed to its base. Hence no strain should ever be put between the tube and its base as this would be apt to loosen it and allow air to leak in. To sum up, then, a vacuum tube should be handled very carefully. It is as easy to damage as an egg is to break.

Many tubes are burned out by applying too high a voltage to the filament. Never use a voltage higher than that for which the tube is rated. A frequent cause of burning out a tube lies in faulty connections of the plate (B) battery. This battery, which always has a comparatively high potential, has its negative terminal connected to one side of the filament. It often happens that the insulation on the positive lead of the plate battery becomes worn out. Any movement of the receiving set is likely to cause the uninsulated part to come into contact with an uninsulated part of the filament lead. This throws a high potential across the filament and it immediately burns out. It is well to check over the wiring when a tube burns out to see that there is no fault or short circuit in it.

With ordinary care tubes should last a long time. Speaking only of tubes used in receivers or amplifiers, practically the only wear that takes place is in the filament. As is well known, the filament, when heated, emits electrons. Although new electrons take their place, the filament undergoes slow disintegration. Thus with perfect mechanical care a tube will in time become useless. However, much can be done to prolong the life of a tube.

The brighter the filament burns, the more rapidly it disintegrates and hence the filament should be lighted up just enough to give the desired result in the signals. The dimmer the filament is lighted the longer the tube will last. A curve showing how the current passing through a tube varies with the temperature of the filament is shown in Fig. 1. The curve gives a good indication of how a

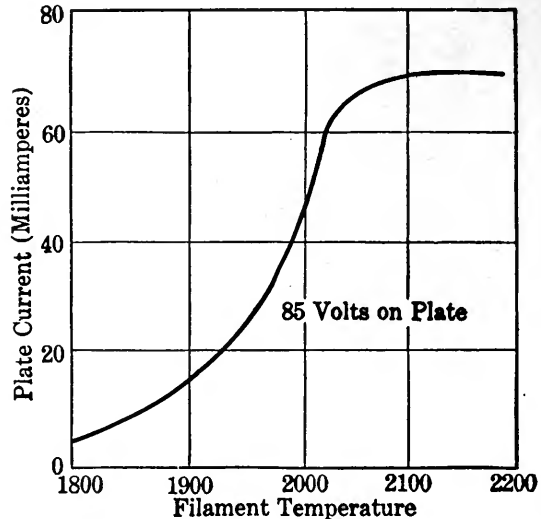

Fig. 1. Curve illustrating electronic flow for various filament temperatures

change in filament temperature changes the number of electrons which it emits. As it is the current passing through the filament which makes it hot, a method of controlling the current will also control the temperature of the filament. Control of the current is secured by the use of a rheostat. A rheostat is a resistance which may be varied at will.

A rheostat in addition to giving control over the brightness of the filament permits it to be heated up and cooled

The Book that brings Radio into the home -

What the Book Contains

Section 1. HOW RADIO ENTERS THE HOME. Contains just the information sought by the man who wants to buy a set. What set shall I buy? How much does it cost? What will it do? This section answers a hundred such questions. All types of sets are described from the least to the most expensive. Full installing and operating instructions.

Section 2. HOW TO RECEIVE MOST EFFICIENTLY. Important receiving accessories are described in language that the layman can understand. For the benefit of the amateur, technical data are given on audio and radio frequency amplification, erection of antennae, battery charging, regeneration, etc. Valuable receiving-circuit diagrams are published for the first time.

Section 3. VACUUM TUBE TRANSMISSION FOR THE AMATEUR AND EXPERIMENTER. Everything from A to Z about transmission with new, completely revised transmitting-diagram, incorporating radiotron transmission and kenotron rectification. Valuable operating instructions are given, and the use of mica condensers for transmission is emphasized.

Section 4. GENERAL INFORMATION - A VERIFIABLE GUIDE BOOK TO RADIO. Government laws, National Electric Code Radio Rules, vacuum-tube "Don'ts," list of broadcasting stations, radio glossary, specifications for a scientifically constructed amateur station, complete price list of all R C A equipment.



Price
35c

FOR the first time a book is published at a small price which gives the public all that it should know about radio. It is called "Radio Enters the Home," and it is written by experts. It tells how to enjoy popular radio broadcasting, and it gives complete descriptions of apparatus and installation instructions. No book so richly illustrated, so accurate, and yet so understandable has thus far been published.

The book is divided into sections. Over 200 illustrations, 112 pages, size 8" x 11". The technically uninformed man will find in sections written especially for him the simply presented facts that he seeks; in other sections are data and diagrams that appeal to the trained amateur.

PRICE, AT YOUR DEALER . . . 35 cents

If your dealer has exhausted his supply, send 35 cents to

Radio Corporation
of America

Sales Division, Suite 1807
233 Broadway, New York City

down gradually for it provides a means of gradually turning on and off the current. This gradual change of temperature of the filament reduces to a minimum the danger of the filament breaking due to the expansion and contraction occurring when a change of temperature takes place. Still other advantages of a rheostat lie in the facts that it gives some control over a noisy amplifier; that it sometimes aids in eliminating interference; and that, by its use, any fluctuation in the filament battery potential may be equalized.

Many detectors and amplifiers are provided with a rheostat, but, in case yours is not, one can be easily made. Three different types are shown in figures 2, 3, and 4. The total amount of resistance should be about one ohm. Less than this may be used if the receiving set has been carefully designed. Bare resistance wire should be used. In figure 2 the resistance wire is wrapped spirally around

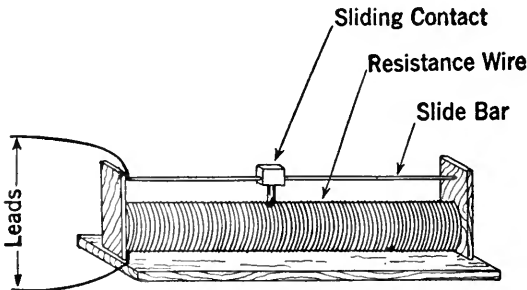

Fig. 2. A typical cylindrical rheostat provided with a slider for altering the number of turns of resistance wire in use

a form made of some insulating material. To one end of the resistance wire and also to the slide bar are spliced wires of negligible resistance to form the leads. The other end of the resistance wire is fastened to the form, but not connected electrically to any other wire. The slide bar is a conductor made of stiff material. The sliding contact should be wide enough to touch two turns of wire as it passes from one to another and narrow enough so that it

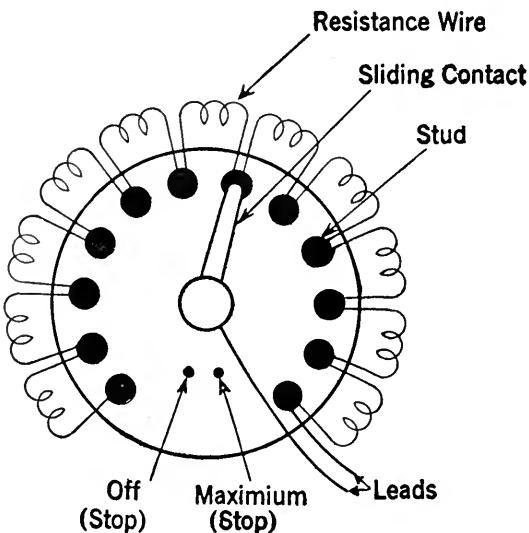

Fig. 3. One method of making a rheostat for front-of-panel mounting. The studs are mounted on the panel and are connected to the resistance coils in the rear

can be made to touch only one turn when it is centred. In winding the resistance wire leave enough space beyond its free end so that the sliding contact can be pushed beyond the wire thus breaking the circuit.

Figure 3 shows how to make a panel rheostat. The studs and the sliding contact are mounted on the face of the panel. The resistance wire, which is soldered to the studs as shown, is in the rear of the panel. Two small stops (Off and Maximum) prevent the contact from being moved too far. The sliding contact must be broad enough to touch both studs as it passes from one to the other and yet narrow enough to touch only one stud when it is centred over it. The leads should be made of wire of low resistance.

A very easily made rheostat is shown in Fig. 4. Resistance wire is wound spirally on a small cylinder ($\frac{1}{4}$ to

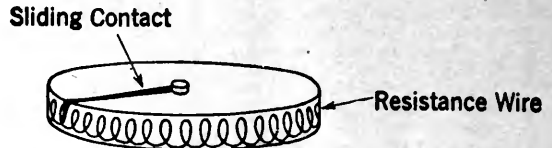

Fig. 4. This is a very popular form of rheostat. The shaft to which the sliding contact is connected is generally made long enough to carry the usual control knob as well as to permit either front or rear of panel mounting. A rheostat of this type permits accurate adjustment of the filament temperature

$\frac{1}{4}$ inch). It is then slipped off and put on the outside of a circular block of insulating material as shown in the figure. A groove must be made on the edge of the block to prevent the wire from slipping out of place. The spiral is stretched just enough to prevent adjacent turns of the wire from touching. As in the other rheostats the wire used for leads must be of low resistance.

The Three-Slide Tuner

Will you please inform me as to the advantage of the three slide type of tuning coil for radio receiving set over the two slide type?

—H. H., Chicago, Ill.

THE question asked will be answered by showing first the necessity of having a flexible coupling between the primary and secondary circuits in the receiving set and then by showing the advantage of the 3-slide tuner over the 2-slide tuner in this respect.

In the receiving set the antenna (primary) circuit is tuned to the frequency of the signals which it is desired to receive. The current in the antenna circuit from these signals becomes large while the current from signals of other frequencies remains small. This is due to the resonance effect obtained by tuning in. It is thus seen that the antenna circuit makes a selection from the radio waves that may be present at the antenna. The secondary, which is also tuned to the desired signals, is another resonant circuit and further eliminates any currents that may arise in the primary from signals which it is not desired to receive.

One of the important factors that necessitates two selective circuits in the receiving set lies in the fact that most of the detectors or rectifiers in use have a high resistance and, if included in the antenna circuit, will give that circuit a high resistance. This is fatal to good selectivity as a study of Fig. 1 will show. This figure shows the current established in a circuit tuned to 400 meters by radio waves of different wavelengths. Three different curves are shown.

WESTINGHOUSE RADIO BATTERIES

Eliminate all Battery Troubles from Radio Sets

The Westinghouse "A" Battery is a full capacity, low voltage, slow discharge, long-life storage battery built exclusively for radio work.

For "B" battery requirements Westinghouse has perfected a baby storage battery. No more throwing away exhausted cells. No more continuous "B" battery expense.

The Westinghouse "B" is a permanent battery. It never has to be replaced. It will discharge its load with constant, steady voltage. Then it can easily be recharged. It gives continuous service to the point of exhaustion without growing "scratchy." If your vacuum tube is inclined to be noisy you can adjust the contact on the Westinghouse "B" to take off the exact voltage the V. T. requires.

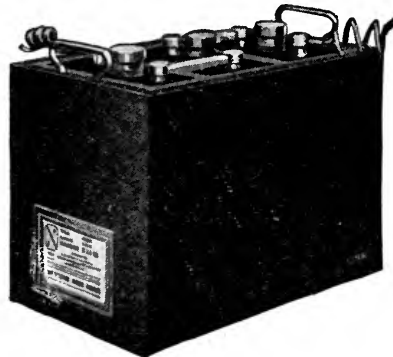

Get a Westinghouse "A" and "B" from your dealer or the nearest Westinghouse Battery Service Station and eliminate all your radio battery troubles.

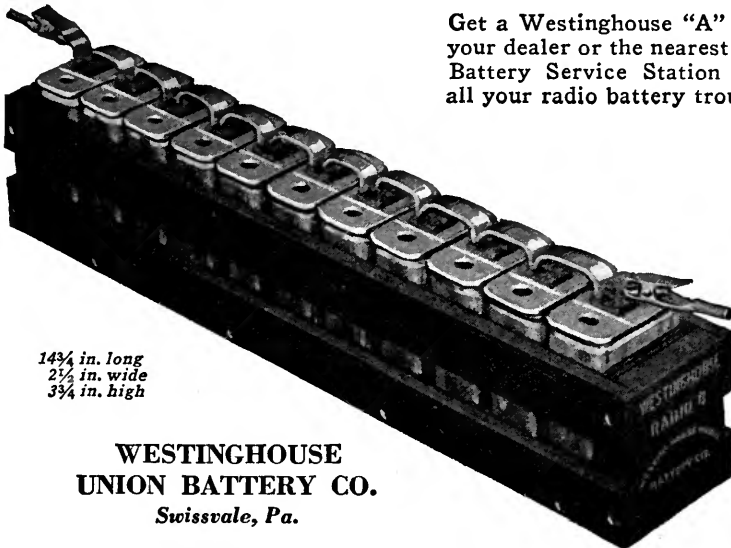

14¾ in. long
2½ in. wide
3¾ in. high

WESTINGHOUSE
UNION BATTERY CO.
Swissvale, Pa.

*"The best
Westinghouse
can build."*

Curve A shows the response of a circuit of moderate resistance; Curve B shows the response of a circuit of very low resistance; and Curve C shows the response of a circuit

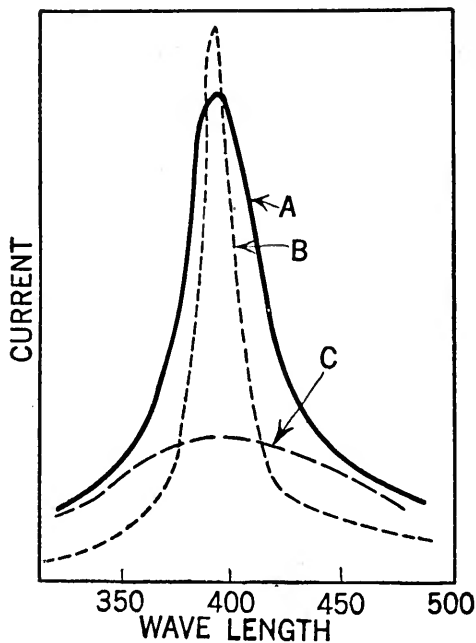

Fig. 1

of high resistance. The last-named circuit is not very selective for it responds almost equally well to many wavelengths. Such would be the response of an antenna circuit having in it a detector of high resistance.

The primary circuit picks up energy and transfers it to the secondary circuit. When two circuits are so arranged that there is a transfer of energy from one to another, the circuits are said to be coupled. Coupling may vary in degree, being "tight" if the effect of one circuit on the other is large; being "loose" if the effect is small. In Fig. 2 is shown how the current in one circuit varied with a change in coupling. The circuits were tuned to each other. Notice that there is a hump in the curve. This means that there is a certain degree for which the current generated in the secondary is greatest.

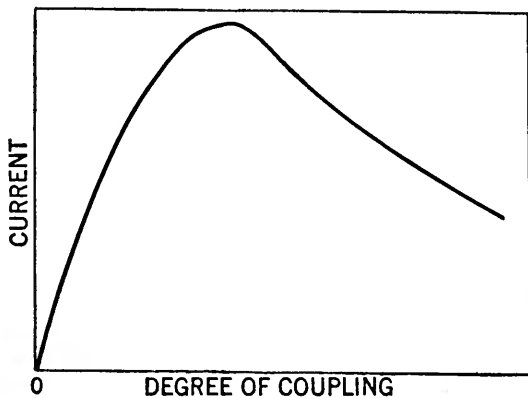

Fig. 2

Another fact about coupled circuits that should be known is that when two circuits are coupled, each circuit has two frequencies at which it will resonate. If the coupling is made loose these frequencies approach each other and may be considered to coincide. Fig. 3 shows the effect on a tuned circuit of coupling to it another circuit tuned to the same frequency. The effect of a tight coupling is shown by curve E. Note that there are two wavelengths to which the tuned circuit will respond well; i.e. there are two humps in the curve. Evidently such a coupling ought not to be used when it is desired to tune out all but one wavelength. The effect of a very loose coupling is shown by curve F. Here the two frequencies have been brought to coincide but the current produced is very small. Curve D illustrates the use of a correct coupling. There is practically

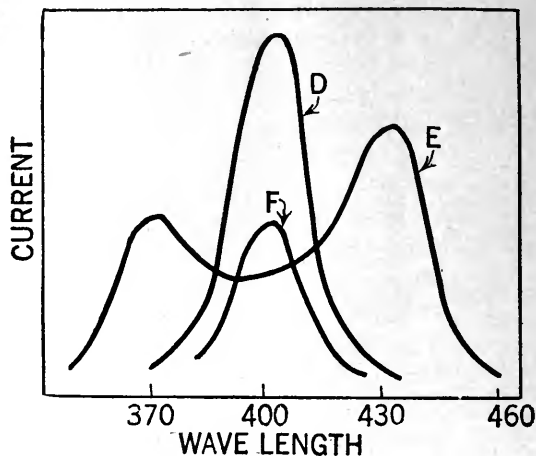

Fig. 3

only one wavelength at which resonance occurs and the current is comparatively large. Coupling adjustment is an important factor in clear reception as can be seen from the above discussion. The correct coupling for any signal is found by trial. In other words, the coupling is varied until the desired result in the signal is obtained.

There are various ways of coupling one circuit to another. The 3-slide tuner uses direct coupling. Part of the coil 1 (Fig. 4) is common to the primary circuit, A-I-G, and also to the secondary circuit, C₂-K-I-N. The connection is thus a direct one. This coil is often called an auto-transformer because the coil transfers the oscillations of one circuit to another and is a part of each circuit. The degree of coupling between the two circuits depends upon the amount of inductance common to both circuits as compared to the amount of inductance in each of the two circuits. It is seen that the amount of inductance in the antenna circuit is governed by the position of the slider, S. The positions of the two sliders, K and N, govern the amount of inductance in the secondary circuit and also the amount of inductance common to both circuits.

In general, the advantage of the 3-slide tuner over the 2-slide tuner lies in the fact that the former is more flexible than the latter. (A 2-slide tuner would be one in which either one of the contacts, K or N, was immovably connected to its end of the coil.) This greater flexibility, gained by having the third contact movable, allows better tuning and coupler adjustments.

One particular advantage of the 3-slide over the 2-slide tuner lies in the fact that for any given degree of coupling,

HOMMEL

Radio Equipment Service For the Dealer

HOW much of an investment must I be prepared to make?

How much of this, that, and other things should I carry?

These are the most vital of the many questions which the prospective dealer must answer—

We can help you answer them, because we have a Dealer Service Department which is devoted to the study of markets, turn-over, the proper selection of radio equipment and other subjects that concern the dealer.

Furthermore, we are distributors for more than 40 of the most prominent manufacturers, and are usually in position to supply most of the dealer's needs from our large stocks.

Write us about your problems—our service will not obligate you in any way.

Catalogue No. 100 B sent upon request.

WHOLESALE ONLY

DISTRIBUTORS FOR

- | | |
|---------------------------------|---------------|
| Radio Corporation of America | |
| Westinghouse | |
| General Electric | |
| Murdock | Acme |
| Fada | Rhamstine |
| Remler | Kellogg |
| Frost | Holtzer-Cabot |
| Brandes | Connecticut |
| Pacent | Burgess |
| General Radio | Hipco |
| Radio Service | Homcharger |
| De Forest | Brach |
| Baldwin | Chelsea |
| Signal | Arkay |
| Clapp-Eastman | |
| and other leading manufacturers | |



LUDWIG HOMMEL & CO

530-534 FERNANDO ST.



PITTSBURGH, PENNA

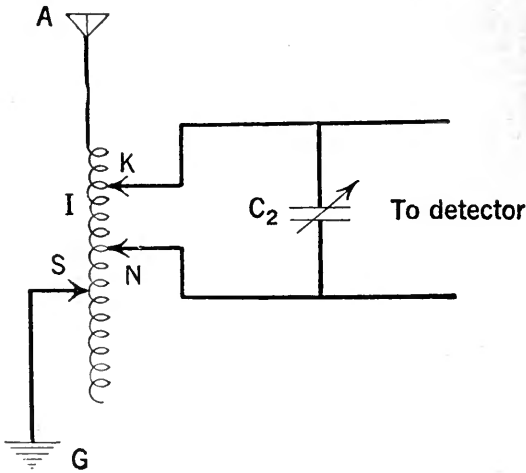

Fig. 4

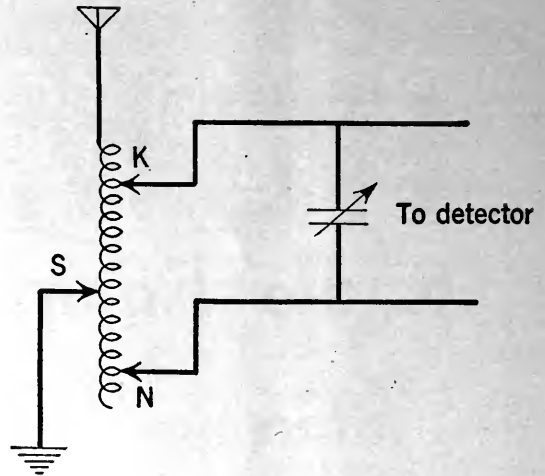

Fig. 5

there is allowed a wider range in the amount of inductance that may be used and hence a greater tuning range for the secondary circuit. A comparison of Fig. 4 and Fig. 5 will make this clear. The amount of inductance in the secondary circuit is greatly different yet the coupling is practically the same. In Fig. 4 the inductance common to both circuits (this is the greatest factor in determining degree of coupling) is that between K and N. In Figure 5 it is that between K and S. The latter is slightly larger than the former in order to compensate for the increase of inductance in the secondary circuit. This slight increase is necessary in order to keep the coupling the same. Of course the inductances between K and N and between K and S could have been made equal if desired.

This control over the amount of inductance in the secondary allows a wide variation in the relative values of the inductance and capacity in the secondary. Thus it permits their adjustment for the best efficiency of the detector. It makes possible the use of a "stiff" circuit, that is, one having a comparatively large inductance. It often happens that the relative resistances, due to faulty construction, etc., of the inductance and capacity vary greatly for their different values. The flexibility gained by the use of the 3-slide tuner enables a greater choice in the values of the capacity and inductance used in tuning in and thus permits one to get an adjustment at which the resistance is the minimum obtainable with that particular circuit.

Present Radio Broadcasting Stations in the United States

List of stations broadcasting market or weather reports (485 meters) and music, concerts, lectures, etc. (360 meters)

OWNER OF STATION	LOCATION OF STATION	WAVE LENGTHS	CALL SIGNAL
Alabama Power Co.	Birmingham, Ala.	360	WSY
Aldrich Marble & Granite Co. C. F.	Colorado Springs, Colo.	485	KHD
Allen, Preston, D.	Oakland, Calif.	360	KZM
Altadena Radio Laboratory	Altadena, Calif.	360	KGO
American Radio & Research Corporation	Medford Hillside, Mass.	360	WGI
Anthony, Earl C.	Los Angeles, Calif.	360	KFI
Arrow Radio Laboratories	Anderson, Ind.	360	WMA
Atlanta Constitution	Atlanta, Ga.	360,485	WGM
Atlanta Journal	Atlanta, Ga.	360,485	WSB
Atlantic-Pacific Radio Supplies Co.	Oakland, Calif.	360	KZY
Auburn Electrical Co.	Auburn, Me.	360	WMB
Bamberger & Co. L.	Newark, N. J.	360	WOR
Beacon Light Co.	Los Angeles, Calif.	360	KNR
Benwood Co.	St. Louis, Mo.	360	WEB
Bible Institute of Los Angeles	Los Angeles, Calif.	360	KJS
Blue Diamond Electric Co.	Hood River, Ore.	360	KOP
Bradley Polytechnic Institute	Peoria, Ill.	360	WBAE
Braun Corporation	Los Angeles, Calif.	360	KXS



Stop Buzzing and Sizzling

FORMICA insulation for Radio use is perfect insulation! It prevents buzzing, sizzling and noise that makes it hard to hear over your radio telephone.

There are no weak places in Formica panels. They are not affected by moisture and weather conditions and do not deteriorate. They will give perfect service for years.

Formica is the most widely used radio insulation. It is approved by the Navy and the Signal Corps. It is a thoroughly high quality product—the finest possible insulating material all the way through! It contains no absorbent matter that will take up water and lose its insulating strength through humidity and moisture.

Formica panels have a handsome gloss or satin finish—black and natural brown.

Dealers: We have now in operation an addition to our plant which doubles our previous capacity. Back orders for Formica are being shipped rapidly. We always do our utmost to serve you promptly.

The Formica Insulation Company

4628 Spring Grove Avenue,

Cincinnati, Ohio

Sales Offices

50 Church Street, New York, N. Y.

9 South Clinton Street, Chicago, Ill.

414 Finance Building, Cleveland, Ohio

1042 Granite Building, Rochester, N. Y.

422 First Ave., Pittsburgh, Pa.

Sheldon Building, San Francisco, Cal.

932 Real Estate Trust Bldg., Philadelphia, Pa.

321 Title Building, Baltimore, Md.

415 Ohio Bldg., Toledo, Ohio

FORMICA

Made from Anhydrous Redmanol Resins

SHEETS TUBES RODS

PRESENT RADIO BROADCASTING STATIONS IN THE UNITED STATES—Continued

OWNER OF STATION	LOCATION OF STATION	WAVE LENGTHS	CALL SIGNAL
Buckeye Radio Service Co.	Akron, Ohio.	360	WOE
Bullock's	Los Angeles, Calif.	360	KNN
Bush, James L.	Tuscola, Ill.	360	WDZ
Central Radio Co.	Kansas City, Mo.	360	WPE
Church of the Covenant	Washington, D. C.	360	WDM
Chicago, City of	Chicago, Ill.	360	WBU
Cino Radio Mfg. Co.	Cincinnati, O.	360	WIZ
City Dye Works & Laundry Co.	Los Angeles, Calif.	360	KUS
Clark University	Worcester, Mass.	360,485	WCN
Coast Radio Company	El Monte, Calif.	360	KUY
Columbia Radio Co.	Youngstown, O.	360	WMC
Commonwealth Electric Co.	St. Paul, Minn.	360	WAAH
Continental Electric Supply Co.	Washington, D. C.	360	WIL
Cooper, Irving S.	Los Angeles, Calif.	360	KZI
Cosradio Co.	Wichita, Kansas.	360,485	WEY
Cox, Warren R.	Cleveland, O.	360	WHK
Crosley Manufacturing Co.	Cincinnati, O.	360	WLW
Daily News Printing Co.	Canton, O.	360	WWB
Dallas, City of	Dallas, Tex.	360,485	WRR
Dayton Co.	Minneapolis, Minn.	360	WBAH
DeForest Radio Telephone & Telegraph Co.	New York, N. Y.	360	WJX
Deseret News	Salt Lake City, Utah.	360	KZN
Detroit News	Detroit, Michigan	360,485	WWJ
Detroit Police Dept.	Detroit, Michigan	360	KOP
Diamond State Fibre Co.	Bridgeport, Pa.	360	WOBAG
Doerr-Mitchell Electrical Co.	Spokane, Wash.	360	KFZ
Doran Brothers Electrical Co.	Hamilton, O.	360	WRK
Doubleday-Hill Electrical Co.	Pittsburgh, Pa.	360	KQV
Doubleday-Hill Electrical Co.	Washington, D. C.	360	WMU
Duck Co., William B.	Toledo, Ohio	360	WHU
Dunn & Co., J. J.	Pasadena, Calif.	360	KLB
Eastern Radio Institute	Boston, Mass.	360	WAAJ
Electric Equipment Co.	Erie, Pa.	360	WJT
Electric Lighting Supply Co.	Hollywood, Calif.	360	GGLY
Electric Power & Appliance Co.	Yakima, Wash.	360	KQT
Electric Supply Co.	Clearfield, Pa.	360	WPI
Elliott Electric Co.	Shreveport, La.	360	WAAG
Emporium, The	San Francisco, Calif.	360	KSL
Erie Radio Co.	Erie, Pa.	360	WSX
Examiner Printing Co.,	San Francisco, Calif.	360	KUO
Fair, The	Chicago, Ill.	360	WGU
Federal Institute of Radio Telegraphy	Camden, N. J.	360	WRP
Federal Telephone & Telegraph Co.	Buffalo, N. Y.	360,485	WGR
Fergus Electric Co.	Zanesville, O.	360	WPL
Findley Electric Co.	Minneapolis, Minn.	360	WCE
First Presbyterian Church	Seattle, Wash.	360	KTW
Ford Motor Co.	Dearborn, Mich.	360	WWI
Fort Worth Record	Fort Worth, Tex.	360	WPA
Foster-Bradbury Radio Store	Yakima, Wash.	360	KFV
General Electric Co.	Schenectady, N. Y.	360	WGY
Gilbert Co., A. C.	New Haven, Conn.	360	WCJ
Gimbel Brothers	Milwaukee, Wisc.	360	WAAK
Gimbel Brothers	Philadelphia, Pa.	360	WIP
Gould, C. O.	Stockton, Calif.	360	KJQ
Groves-Thornton Hardware Co.	Huntington, W. Va.	360	WAAR
Hale & Co.	San Jose, Calif.	360	KSC
Hallock & Watson Radio Service	Portland, Ore.	360	KGG
Hamilton Manufacturing Co.	Indianapolis, Ind.	360	WLK
Hatfield Electric Co.	Indianapolis, Ind.	360	WOH
Hawley, Willard P. Jr.	Portland, Ore.	360	KYG
Herald Publishing Co.	Modesto, Calif.	360	KXD
Herrold, Charles D.	San Jose, Calif.	360	KQW
Hobrecht, J. C.	Sacramento, Calif.	360	KVQ
Hollister-Miller Motor Co.	Emporia, Kansas	360	WAAZ
Holzwasser Inc.	San Diego, Calif.	360	KON
Howe, Richard H.	Granville, Ohio.	360	WJD
Howlett, Thomas. F. J.	Philadelphia, Pa.	360	WGL
Hunter, L. M. & G. L. Carrington	Little Rock, Ark.	360	WSV
Hurlburt-Still Electrical Co.	Houston, Tex.	360,485	WEV
Interstate Electric Co.	New Orleans, La.	360	WGV
Iowa Radio Corporation.	Des Moines, Iowa.	360	WHX

The Multiple Storage Battery Corporation Announces
RADIOBAT "B"

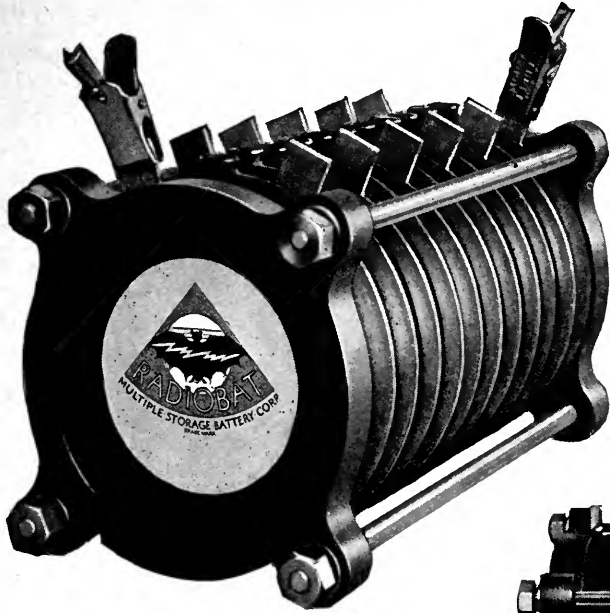

The Most Remarkable "B" Type Radio Battery. Revolutionary in Design and Construction.

Radiobat "B" is practically everlasting. It has no glass to break, no wooden case to rot, no separators of any kind.

Radiobat "B" is leak proof, it is free from acid fumes.

Any voltage desired can be obtained simply and easily.

Radiobat "B" will give a clearer tone to your Radio.

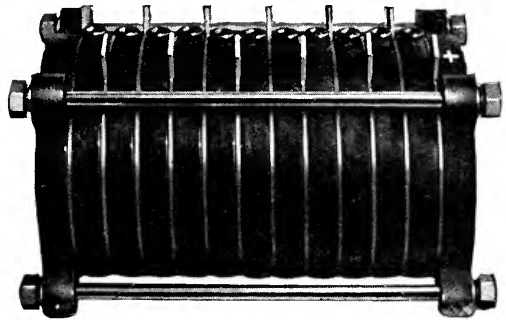

As Radiobat "B" has just been placed on the market, it is possible that your regular dealer will not be able to supply it. If this is the case, write us to-day enclosing \$12.00, the price of this extraordinary battery.

Also for Laboratories and Experimenters interested in high voltage with low amperage.

Dealers write at once for our proposition

**MULTIPLE
STORAGE BATTERY CORP.**



Established 1908

350 Madison Avenue

New York

PRESENT RADIO BROADCASTING STATIONS IN THE UNITED STATES—Continued

OWNER OF STATION	LOCATION OF STATION	WAVE-LENGTHS	CALL SIGNAL
J. & M. Electric Co.	Utica, N. Y.	360	WSL
K. & L. Electric Co.	McKeesport, Pa.	360	WIK
Kansas State Agricultural College	Manhattan, Kansas	485	WTG
Karlowa Radio Co.	Rock Island, Ill.	360,485	WOC
Kennedy Co., Colin B.	Los Altos, Calif.	360	KLP
Kierulff & Co., C. R.	Los Angeles, Calif.	360	KHJ
Kluge, Arno A.	Los Angeles, Calif.	360	KQL
Kraft, Vincent I.	Seattle, Wash.	360,485	KJR
Lindsay, Weatherill & Co.	Reedley, Calif.	360	KMC
Los Angeles Examiner	Los Angeles, Calif.	360	KWH
Love Electric Co.	Tacoma, Wash.	360	KMO
Loyola University	New Orleans, La.	360	WWL
Marshall-Gerkin Co.	Toledo, Ohio.	360	WBA
Maxwell Electric Co.	Berkeley, Calif.	360	KRE
May (Inc.) D. W.	Newark, N. J.	360	WBS
McBride, George M.	Bay City, Mich.	360	WTP
McCarthy Bros. & Ford	Buffalo, N. Y.	360	WWT
Metropolitan Utilities District	Omaha, Nebraska	360,485	WOU
Meyberg Co., Leo J.	Los Angeles, Calif.	360,485	KYJ
Meyberg Co., Leo J.	San Francisco, Calif.	360,485	KDN
Middleton, Fred M.	Morestown, N. J.	360	WBAFG
Midland Refining Co.	El Dorado, Kansas	485	WAH
Midland Refining Co.	Tulsa, Okla.	485	WEH
Millikin University James,	Decatur, Ill.	360	WBAO
Minnesota Tribune Co. & Anderson Beamish Co.	Minneapolis, Minn.	360	WAAL
Missouri State Marketing Bureau.	Jefferson City, Mo.	485	WOS
Modesto Evening News	Modesto, Calif.	360	KOQ
Montgomery Light & Power Co.	Montgomery, Ala.	360,485	WGH
Mullins, Electric Co., Wm. A.	Tacoma, Wash.	360	KGB
Mulrony, Marion A.	Honolulu, Hawaii	360	KGU
Nelson Co. I. R.	Newark, N. J.	360	WAAM
New England Motor Sales Co.	Greenwich, Conn.	360	WAAQ
New Mexico College of Agriculture and Mechanical Arts.	State College, N. Mex.	360,485	KOB
Newspaper Printing Co.	Pittsburgh, Pa.	360	WPB
Noggle Electric Works	Monterey, Calif.	360	KLN
North Coast Products Co.	Aberdeen, Wash.	360	KNT
Northern Radio & Electric Co.	Seattle, Wash.	360	KFC
Northwestern Radio Manufacturing Co.	Portland, Ore.	360	KGN
Nushawg Poultry Farm	New Lebanon, Ohio.	360	WPG
Oklahoma Radio Shop	Oklahoma City, Okla.	360,485	WKY
Oregonian Publishing Co.	Portland, Ore.	360	KGW
Palladium Printing Co.	Richmond, Ind.	360,485	WOZ
Paris Radio Electric Co.	Paris, Tex.	360	WTK
Pennsylvania State Police	Harrisburg, Pa.	360	WBAX
Pine Bluff Co.	Pine Bluff, Ark.	360	WOK
Pomona Fixture & Wiring Co.	Pomona, Calif.	360	KGF
Portable Wireless Telephone Co.	Stockton, Calif.	360	KWG
Post Dispatch.	St. Louis, Mo.	360	KSD
Precision Equipment Co.	Cincinnati, Ohio.	360,485	WMH
Precision Shop, The	Gridley, Calif.	360	KFU
Prest & Dean Radio Research Laboratory	Long Beach, Calif.	360	KSS
Public Market & Department Stores Co.	Seattle, Wash.	360	KZC
Purdue University	West Lafayette, Ind.	360	WBAA
Radio Construction & Electric Co.	Washington, D. C.	360	WDW
Radio Service Co.	Charleston, W. Va.	360	WAAO
Radio Shop, The	Sunnyvale, Calif.	360	KJJ
Radio Telephone Shop, The	San Francisco, Calif.	360	KYY
Radio Supply Co.	Los Angeles, Calif.	360	KNV
Register & Tribune, The	Des Moines, Iowa.	360	WGF
Rennysen, I. B.	New Orleans, La.	360	WBAM
Reynolds Radio Co.	Denver, Colorado	360,485	KLZ
Ridgewood Times Printing & Publishing Co.	Ridgewood, N. Y.	360	WHN
Riechman-Crosby Co.	Memphis, Tenn.	360,485	WKN
Rike-Kumler Co.	Dayton, Ohio.	360,485	WFO
Rochester Times Union	Rochester, N. Y.	360,485	WHQ
Roswell Public Service Co.	Roswell, N. Mex.	360	KNJ
St. Joseph's College	Philadelphia, Pa.	360	WPJ
St. Louis Chamber of Commerce	St. Louis, Mo.	360	WAAE
St. Louis University,	St. Louis, Mo.	485	WEW
St. Martins College (Rev. S. Ruth)	Lacey, Wash.	360	KGY
San Joaquin Light & Power Corporation.	Fresno, Calif.	360	KMJ

Exide

BATTERIES



For uniform filament current

To meet the requirements of radio service, the Exide Radio Battery was specially designed for the maintenance of a uniform voltage during a long period of discharge. You will take great satisfaction in a battery whose voltage does not drop quickly to a point where frequent adjustment of the apparatus is necessary.

Plates, separators, jars, terminals, every part and each detail of this battery is the result of the experience of the makers of Exide in building batteries for every purpose since the beginning of the storage battery industry.

Exide Batteries are used by governments and great industries all over the world. They propel mine locomotives and submerged submarines; they operate the fire alarm system and send your voice over the Bell telephone. Most of the government and Radio Corporation wireless plants are equipped with Exide Batteries.

You can get Exide Radio Batteries at every place where radio equipment is sold and also at all Exide Service Stations.



THE ELECTRIC STORAGE BATTERY CO.
Philadelphia

*Oldest and largest manufacturers in the world of
storage batteries for every purpose*

PRESENT RADIO BROADCASTING STATIONS IN THE UNITED STATES—Continued

OWNER OF STATION	LOCATION OF STATION	WAVE LENGTHS	CALL SIGNAL
Seeley, Stuart, W.	East Lansing, Mich.	485	WHW
Service Radio Equipment Co.	Toledo, Ohio.	360	WJK
Ship Owners Radio Service	New York, N. Y.	360	WDT
Ship Owners Radio Service	Norfolk, Va.	360	WSN
Shotton Radio Manufacturing Co.	Albany, N. Y.	360	WNJ
Southern Electrical Co.	San Diego, Calif.	360	KDPT
Southern Radio Corporation	Charlotte, N. C.	360	WBT
Spokane Chronicle	Spokane, Wash.	360	KOE
Standard Radio Co.	Los Angeles, Calif.	360	KJC
Sterling Electric Co. & Journal Printing Co.	Minneapolis, Minn.	360	WBAD
Stix-Baer-Fuller	St. Louis, Mo.	360	WCK
Strawbridge & Clothier	Philadelphia, Pa.	360	WFI
Stubbs Electric Co.	Portland, Ore.	360	KOY
T. & H. Radio Co.	Anthony, Kansas	360	WBL
Tarrytown Radio Research Laboratory	Tarrytown, N. Y.	360	WRW
Taylor, Otto W.	Wichita, Kansas.	360	WAAP
Thearle Music Co.	San Diego, Calif.	360	KYF
Tulane University of Louisiana.	New Orleans, La.	360	WAAC
Union College	Schenectady, N. Y.	360	WRL
Union Stock Yards & Transit Co.	Chicago, Illinois	360,485	WAAF
United Equipment Co.	Memphis, Tenn.	360	WPO
University of Illinois	Urbana, Illinois	360	WRM
University of Minnesota.	Minneapolis, Minn.	360,485	WLB
University of Missouri	Columbia, Mo.	360	WAAN
University of Texas	Austin, Texas	360,485	WCM
University of Wisconsin	Madison, Wisconsin	360,485	WHA
Wanamaker, John	Philadelphia, Pa.	360	WOO
Wanamaker, John	New York, N. Y.	360	WWZ
Warner Brothers	Oakland, Calif.	360	KLS
Wasmer, Louis	Seattle, Wash.	360	KHQ
West Virginia University	Morgantown, W. Va.	360	WHD
Western Radio Co.	Kansas City, Mo.	360,485	WOQ
Western Radio Electric Co.	Los Angeles, Calif.	360	KOG
Westinghouse Electric & Manufacturing Co.	East Pittsburgh, Pa.	360	KDKA
Westinghouse Electric & Manufacturing Co.	Chicago, Ill.	360,485	KYW
Westinghouse Electric & Manufacturing Co.	Newark, N. J.	360	WJZ
Westinghouse Electric & Manufacturing Co.	Springfield, Mass.	360	WBZ
White & Boyer Co.	Washington, D. C.	360	WJH
Williams, Thomas J.	Washington, D. C.	360	WPM
Wireless Phone Corporation	Paterson, N. J.	360	WBAN
Wireless Telephone Co. of Hudson County, N. J.	Jersey City, N. J.	360	WNO
Yeiser, John O. Jr.	Omaha, Nebraska	360	WDV
Young Men's Christian Association	Denver, Colo.	485	KOA
Zamoiski Co., Joseph M.	Baltimore, Md.	360	WKC

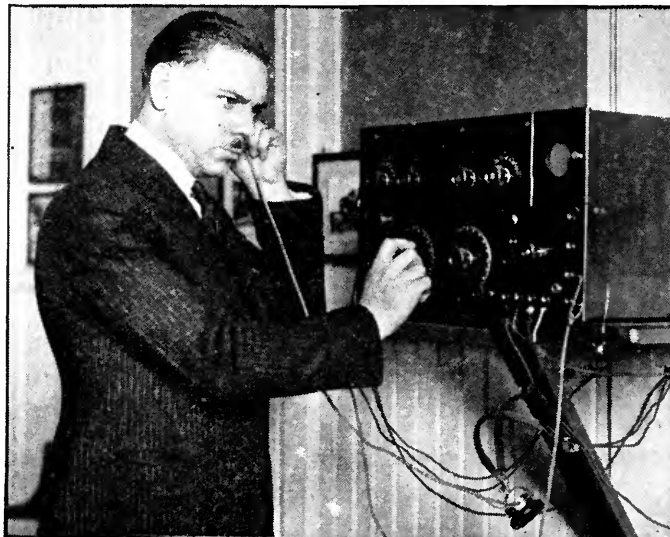

Radio Broadcasting has been perfected to a degree where the appearance of the Critic has become necessary. The public demands the highest class of entertainment, and large radio broadcasting stations check up their own work in this manner